

aiwa

COMPACT DISC STEREO SYSTEM  
SISTEMA ESTEREO CON REPRODUCTOR DE DISCOS COMPACTOS  
CHAINE STEREO AVEC LECTEUR DE DISQUES COMPACTS

# CX-NDS15

– For NSX-DS11 and  
NSX-DS15

OPERATING INSTRUCTIONS  
MANUAL DE INSTRUCCIONES  
MODE D'EMPLOI

En (English)

E (Español)

F (Français)

For assistance and information,  
**call toll Free 1-800-BUY-AIWA.**  
(United States and Puerto Rico)

## WARNING

TO REDUCE THE RISK OF FIRE OR ELECTRIC SHOCK, DO NOT EXPOSE THIS APPLIANCE TO RAIN OR MOISTURE.



### Explanation of Graphical Symbols:



The lightning flash with arrowhead symbol, within an equilateral triangle, is intended to alert the user to the presence of uninsulated "dangerous voltage" within the product's enclosure that may be of sufficient magnitude to constitute a risk of electric shock to persons.



The exclamation point within an equilateral triangle is intended to alert the user to the presence of important operating and maintenance (servicing) instructions in the literature accompanying the appliance.

### Owner's record

For your convenience, record the model number and serial number (you will find them on the rear of your unit) in the space provided below. (Please refer to them when you contact your Aiwa dealer in case of difficulty.)

Model No.	Serial No. (Lot No.)
CX-NDS15	
SX-ND8	
SX-C605	
SX-R275	
TS-W45 (NSX-DS15 only)	

## PRECAUTIONS

Read the Operating Instructions carefully and completely before operating the unit. Be sure to keep the Operating Instructions for future reference. All warnings and cautions in the Operating Instructions and on the unit should be strictly followed, as well as the safety suggestions below.

### Installation

- 1 Water and moisture** — Do not use this unit near water, such as near a bathtub, washbowl, swimming pool, or the like.
- 2 Heat** — Do not use this unit near sources of heat, including heating vents, stoves, or other appliances that generate heat. It also should not be placed in temperatures less than 5°C (41°F) or greater than 35°C (95°F).

- 3 Mounting surface** — Place the unit on a flat, even surface.
- 4 Ventilation** — The unit should be situated with adequate space around it so that proper heat ventilation is assured. Allow 10 cm (4 in.) clearance from the rear and the top of the unit, and 5 cm (2 in.) from each side.
  - Do not place the unit on a bed, rug, or similar surface that may block the ventilation openings.
  - Do not install the unit in a bookcase, cabinet, or airtight rack where ventilation may be impeded.
- 5 Objects and liquid entry** — Take care that objects or liquids do not get inside the unit through the ventilation openings.
- 6 Carts and stands** — When placed or mounted on a stand or cart, the unit should be moved with care. Quick stops, excessive force, and uneven surfaces may cause the unit or cart to overturn or fall.
- 7 Condensation** — Moisture may form on the CD pickup lens when:
  - The unit is moved from a cold spot to a warm spot
  - The heating system has just been turned on
  - The unit is used in a very humid room
  - The unit is cooled by an air conditioner
 When this unit has condensation inside, it may not function normally. Should this occur, leave the unit for a few hours, then try to operate again.
- 8 Wall or ceiling mounting** — The unit should not be mounted on a wall or ceiling, unless specified in the Operating Instructions.



### Electric Power

- 1 Power sources** — Connect this unit only to power sources specified in the Operating Instructions, and as marked on the unit.
- 2 Polarization** — As a safety feature, some units are equipped with polarized AC power plugs which can only be inserted one way into a power outlet. If it is difficult or impossible to insert the AC power plug into an outlet, turn the plug over and try again. If it still does not easily insert into the outlet, please call a qualified service technician to service or replace the outlet. To avoid defeating the safety feature of the polarized plug, do not force it into a power outlet.
- 3 AC power cord**
  - When disconnecting the AC power cord, pull it out by the AC power plug. Do not pull the cord itself.
  - Never handle the AC power plug with wet hands, as this could result in fire or shock.
  - Power cords should be routed to avoid being severely bent, pinched, or walked upon. Pay particular attention to the cord from the unit to the power socket.
  - Avoid overloading AC power plugs and extension cords beyond their capacity, as this could result in fire or shock.
- 4 Extension cord** — To help prevent electric shock, do not use a polarized AC power plug with an extension cord, receptacle, or other outlet unless the polarized plug can be completely inserted to prevent exposure of the blades of the plug.
- 5 When not in use** — Unplug the AC power cord from the AC power plug if the unit will not be used for several months or more. When the cord is plugged in, a small amount of current continues to flow to the unit, even when the power is turned off.

## Outdoor Antenna

- 1 Power lines** — When connecting an outdoor antenna, make sure it is located away from power lines.
- 2 Outdoor antenna grounding** — Be sure the antenna system is properly grounded to provide protection against unexpected voltage surges or static electricity build-up. Article 810 of the National Electrical Code, ANSI/NFPA 70, provides information on proper grounding of the mast, supporting structure, and the lead-in wire to the antenna discharge unit, as well as the size of the grounding unit, connection to grounding terminals, and requirements for grounding terminals themselves.

Antenna Grounding According to the National Electrical Code

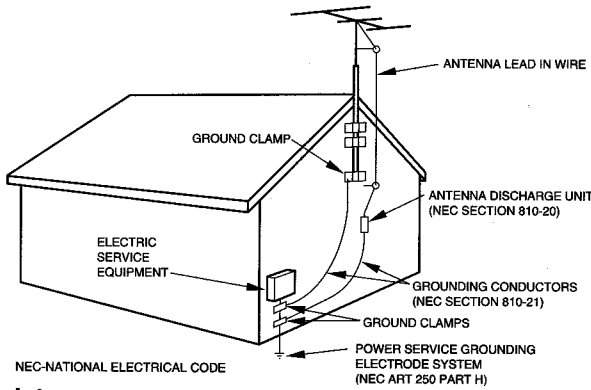

## Maintenance

Clean the unit only as recommended in the Operating Instructions.

## Damage Requiring Service

Have the units serviced by a qualified service technician if:

- The AC power cord or plug has been damaged
- Foreign objects or liquid have got inside the unit
- The unit has been exposed to rain or water
- The unit does not seem to operate normally
- The unit exhibits a marked change in performance
- The unit has been dropped, or the cabinet has been damaged

**DO NOT ATTEMPT TO SERVICE THE UNIT YOURSELF.**

## Check your system and accessories.

### NSX-DS11

CX-NDS15 Compact disc stereo cassette receiver  
 SX-ND8 Front speakers  
 SX-R275 Surround speakers  
 SX-C605 Center speaker

### NSX-DS15

CX-NDS15 Compact disc stereo cassette receiver  
 SX-ND8 Front speakers  
 SX-R275 Surround speakers  
 SX-C605 Center speaker  
 TS-W45 Subwoofer

Remote control

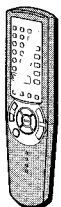

AM antenna



FM antenna

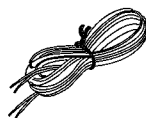

Operating Instructions, etc.

# TABLE OF CONTENTS

PRECAUTIONS .....	1
<b>PREPARATIONS</b>	
SETTING UP .....	3
REMOTE CONTROL .....	5
BEFORE OPERATION .....	6
<b>SOUND</b>	
AUDIO ADJUSTMENTS .....	7
RHYTHM PLAY FUNCTION (BEAT MASTER DX) .....	8
GRAPHIC EQUALIZER (GEQ) .....	11
DSP SURROUND .....	12
<b>CD PLAYING</b>	
BASIC OPERATIONS .....	13
PROGRAMMED PLAY .....	15
<b>RADIO RECEPTION</b>	
MANUAL TUNING .....	16
PRESETTING STATIONS .....	16
<b>TAPE PLAYBACK</b>	
BASIC OPERATIONS .....	17
CONTINUOUS PLAY .....	18
<b>RECORDING</b>	
BASIC RECORDING .....	19
DUBBING A TAPE MANUALLY .....	20
DUBBING THE WHOLE TAPE .....	20
AI EDIT RECORDING .....	21
PROGRAMMED EDIT RECORDING .....	22
<b>DOLBY SURROUND</b>	
SELECTING DOLBY SURROUND .....	23
ADJUSTING SPEAKER LEVEL BALANCE .....	24
ADJUSTING DOLBY DIGITAL SURROUND SOUND .....	26
<b>KARAOKE</b>	
MICROPHONE MIXING .....	27
KARAOKE PROGRAM .....	29
<b>CLOCK AND TIMER</b>	
SETTING THE CLOCK .....	30
SETTING THE SLEEP TIMER .....	30
SETTING THE TIMER .....	31
<b>OTHER CONNECTIONS</b>	
CONNECTING OPTIONAL EQUIPMENT .....	32
LISTENING TO EXTERNAL SOURCES .....	33
<b>GENERAL</b>	
CARE AND MAINTENANCE .....	34
TROUBLESHOOTING GUIDE .....	34
SPECIFICATIONS .....	35
PARTS INDEX .....	Back cover

En

## PREPARATIONS

# SETTING UP

Complete setting and connection of the main unit, supplied speakers, your TV and video equipment according to the following procedure.

## POSITIONING THE SPEAKERS

Position the speakers to make the most of the Dolby Digital Surround, Dolby Pro Logic or DSP effect.

### ① Front speakers

### ② Center speaker

Position in the center of the two front speakers. In addition, position on or below the TV set, if connecting a TV set to the unit.

### ③ Surround speakers

Place the surround speakers directly to the side of or slightly behind the listening area. Align them horizontally, about 1 meter (3.2 feet) above ear height.

### ④ Subwoofer (For NSX-DS15 only)

Place the subwoofer on the floor close to a wall or in a corner of the room.

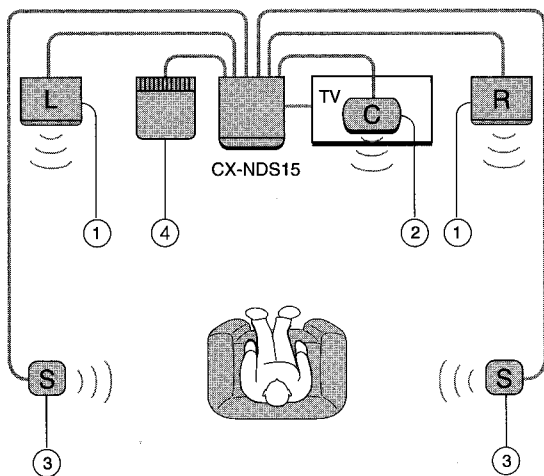

## NOTE

Sound from the surround speakers or center speaker depends on the setting of the DSP, Dolby Pro Logic and Dolby Digital Surround.

## CONNECTIONS

### Before connecting the AC cord

The rated voltage of your unit shown on the rear panel is 120 V AC. Check that the rated voltage matches your local voltage.

### IMPORTANT

Connect the speakers, antennas, and all optional equipment first. Then connect the AC cord.

There are no differences between the front speakers as well as the surround speakers. Both speakers of its kind can be connected as L (left) or R (right).

### 1 Connect the right and left speaker to the main unit.

Connect the right speaker cord to **SPEAKERS R** terminals, and the left to **SPEAKERS L** terminals.

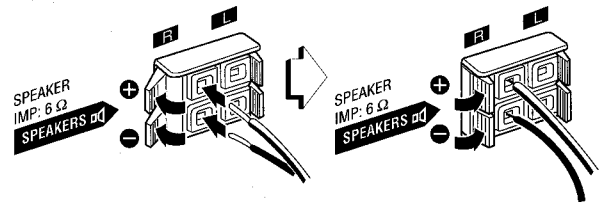

The cords with white stripes should be connected to the **+** terminals and the other cords to the **-** terminals

### 2 Connect the surround speakers to the main unit.

Connect the right surround speaker cord to the **SURROUND SPEAKERS R** terminal, and left to the **SURROUND SPEAKERS L** terminal.

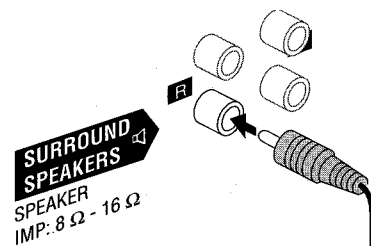

### 3 Connect the center speaker.

Connect the center speaker cord to **CENTER SPEAKER** terminal.

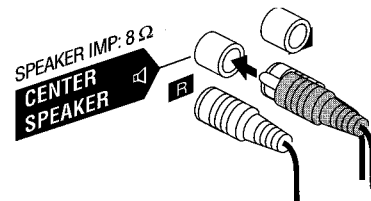

### 4 Connect the supplied antennas.

Connect the FM antenna to the **FM 75 Ω** terminals and the AM antenna to the **AM LOOP** terminal.

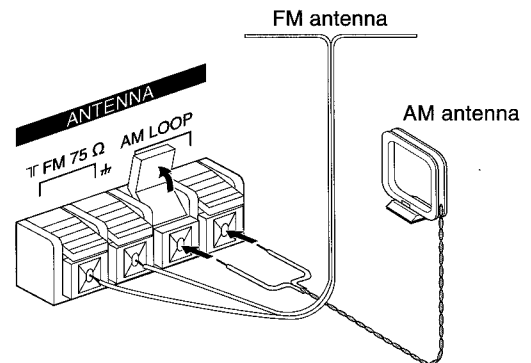

### 5 Connect the subwoofer (only for NSX-DS15).

Connect the subwoofer cord to **SUB WOOFER** terminal.  
• Refer to the Operating Instructions of TS-W45 for the details.

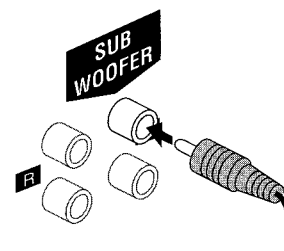

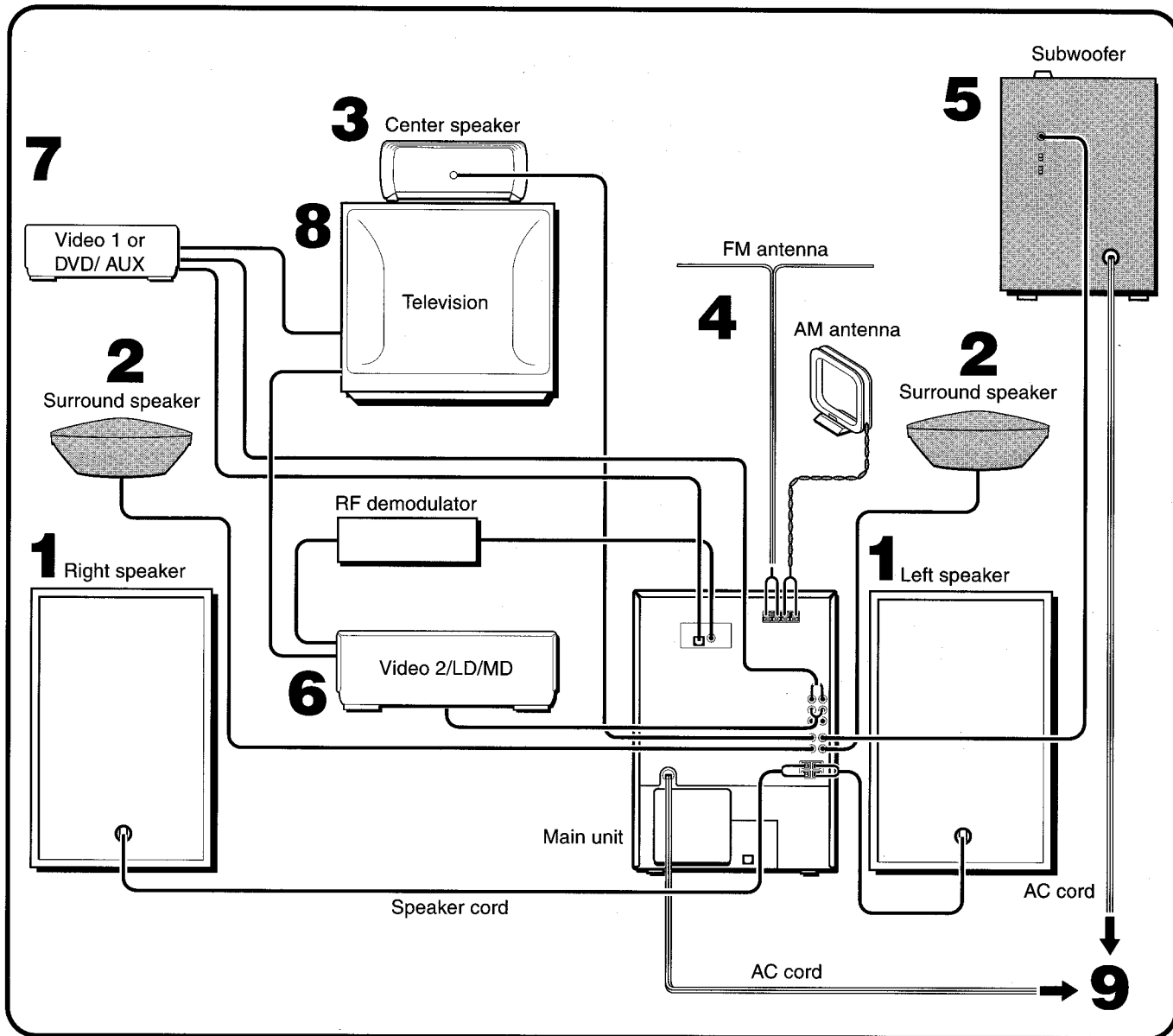

**6 Connect the Video 2\*1 /LD\*2 /MD.**

Connect **VIDEO2/LD/MD** jacks of this unit to the audio output jack of the equipment with an optional audio connecting cord. Then, connect the coaxial digital output jack of the equipment to the **COAXIAL DIGITAL IN** jack of this unit with an optional coaxial connecting cord.

**7 Connect the DVD or Video 1\*1.**

Connect **VIDEO1/DVD/AUX** jacks of this unit to the audio output jack of the equipment with an optional audio connecting cord. Then, connect the optical digital output jack of the equipment to the **OPTICAL DIGITAL IN** jack of this unit with an optional optical connecting cord.

\*1 When connecting a monaural video, use a stereo-mono connecting cord (not supplied).

\*2 When connecting an LD player equipped with the AC-3 RF OUT jack, use an RF demodulator unit. Also connect the analog audio output jacks of the LD player to this unit to play all the sources. For further information, refer to the instructions of the LD player.

**8 Connect the Television to the video equipment.**

Refer to the Operating Instructions of the connected equipment for details.

**9 Connect the AC cord to an AC outlet.**

• The game Demo will begin when the AC cord is plugged into an AC outlet. See page 6 "Game Demo" for details.

**To position the antennas**

**FM feeder antenna:**

Extend this antenna horizontally in a T-shape and fix its ends to the wall.

**AM loop antenna:**

Position to find the best reception.

**To stand the AM antenna on a surface**

Fix the claw to the slot.

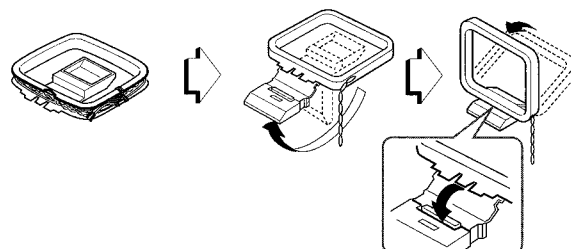

**To mount the surround speaker on the wall**  
Mount each speaker on a spot that can hold its weight.

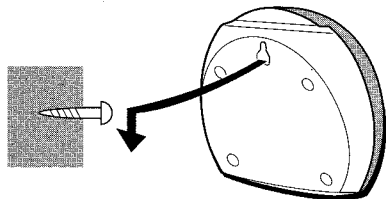

**NOTE**

Sound is not heard from the surround speakers when the SURROUND is set to off.

**NOTE**

• Be sure to connect the speaker cords correctly. Improper connections can cause short circuits in the **SPEAKERS** terminals.

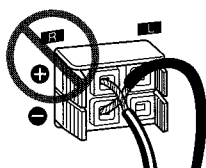

- Do not leave objects generating magnetism near the speakers.
- Do not bring the FM antenna near metal objects or curtain rails.
- Do not bring the AM antenna near other optional equipment, the stereo system itself, the AC cord or speaker cords, since noise will be picked up.
- Do not unwind the AM antenna wire.

**CONNECTING AN OUTDOOR ANTENNA**

For better FM reception, use of an outdoor antenna is recommended.  
Connect the outdoor antenna to the **FM 75 Ω** terminals.

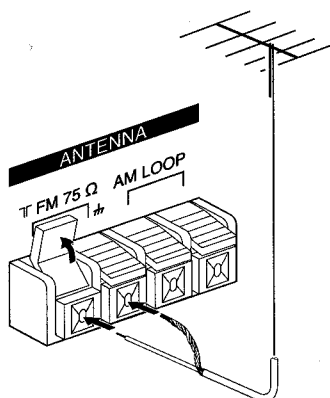

To connect other optional equipment → page 31.

**REMOTE CONTROL**

**Inserting batteries**

Detach the battery cover on the rear of the remote control and insert two size AA (R6) batteries.

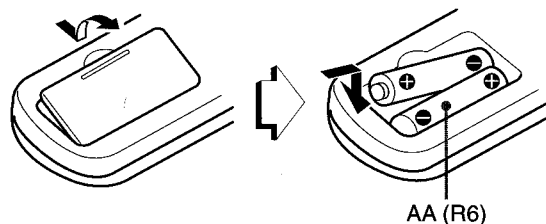

**When to replace the batteries**

The maximum operational distance between the remote control and the sensor on the main unit should be approximately 5 meters (16 feet). When this distance decreases, replace the batteries with new ones.

**Using the remote control**

The instructions in this manual refer mainly to the buttons on the main unit. Buttons on the remote control with the same names as those on the main unit can be used as well.

**▶/◀ PRESET on the remote control**

The function is the same as that of ◀▶ on the main unit.

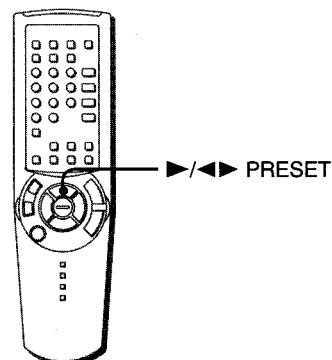

**NOTE**

- If the unit is not going to be used for an extended period of time, remove the batteries to prevent possible electrolyte leakage.
- The remote control may not operate correctly when:
  - The line of sight between the remote control and the remote sensor inside the display window is exposed to intense light, such as direct sunlight
  - Other remote controls are used nearby (those of a television, etc.)

# BEFORE OPERATION

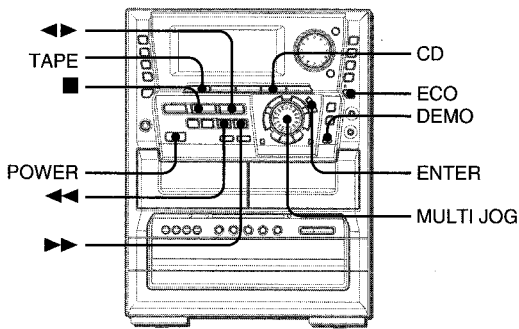

### To turn the power on

Press one of the function buttons (**TAPE**, **TUNER**, **VIDEO 1/DVD/AUX**, **CD**, **VIDEO 2/LD/MD**).

Playback of the inserted disc or tape begins, or the previously tuned station is received (Direct Play Function).

**POWER** is also available.

When the unit is turned on, the disc compartment may open and close to reset the unit.

### To turn the power off

Press **POWER**.

### Illumination guides

Whenever one of the function buttons is pressed, the buttons for that operation light up or flash.

### Flash windows

The windows of the CD compartment and the cassette decks light up or flash while the unit is being powered on.

To turn off the light of the CD window, press **■** while pressing **CD**. To turn back on, repeat the above.

To turn off the light of the cassette decks, press **■** while pressing **TAPE**. To turn back on, repeat the above.

- Do not perform this operation during recording.

### To change the brightness level of the display

- 1 Press **ECO** so that "ECO MODE" is displayed.
- 2 Within 4 seconds, turn **MULTI JOG** to display "DIM MODE", and then press **ENTER** within 4 seconds.
- 3 Within 4 seconds, turn **MULTI JOG** to select the dimmer mode as below.  
The mode will be automatically set after 4 seconds. It will also be set if **ENTER** is pressed within 4 seconds after step 3.

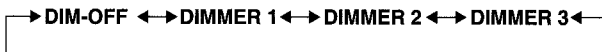

- DIM-OFF:** The normal display.
- DIMMER 1:** The illumination of the display is dimmer than usual.
- DIMMER 2:** The illumination of the display is dimmer than DIMMER 1.
- DIMMER 3:** The illumination of the display is dimmer than DIMMER 2. The spectrum analyzer, the window of the CD compartment and the button lamps light off.

### NOTE

If the timer recording (page 30) is done with the economizing mode (page 7) set to "ON" and the power turns off, the dimmer mode will be set to "DIMMER 3" the next time the power is turned on.

## Game Demo

When the AC cord is plugged for the first time after purchase, the game Demo will begin in the display. When the power is turned on, the game Demo will end.

Until the clock is set, the game Demo will automatically begin whenever the power is turned off.

### To play the game Demo

Press **DEMO** whether the unit is turned on or off, and whether the clock has been set or not.

With the power switched off, the game is silent. With the power switched on, it is livened up with sound.

#### 1 Press ◀▶.

Three numbers on the display start to run.

#### 2 Press ■ once.

The number on the left side stops.

#### 3 Press ■ twice to stop the remaining two numbers.

*Scoring:*

20 points are given to start the game.

If all the numbers are equal, 50 points are added to the score.

If not equal, one point is subtracted.

If the gained points reach 9999, you win.

If the gained points fall to 0, you lose.

To reset the game Demo, press **DEMO** twice.

To cancel the game Demo, press **DEMO**.

### To change the probability of equalizing the three number

Press ◀◀ or ▶▶ repeatedly to select one of the three probability levels when playing the game Demo. The tray number indicator in the display changes between 1 and 3. As the tray number increases from 1 to 3, the higher the probability of equalizing.

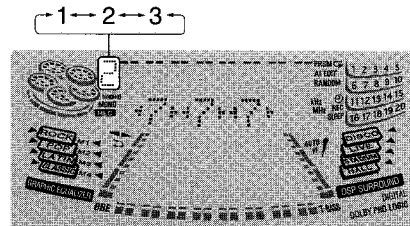

### To mute the game sound

First, cancel the game Demo by pressing **DEMO**. Then, keep pressing **DEMO** until "♪ OFF" is displayed.

To restore the game sound, keep pressing **DEMO** again until "♪ ON" is displayed.

### NOTE

- While playing the game Demo, **■**, **◀◀**, **▶▶** and **◀▶** are available only for the game Demo. Cancel the game Demo to use these buttons for the functions such as CD playing, etc.
- During the game Demo, some indicators unrelated with the actual operation light up on the display.
- To change the game sound, see "RHYTHM PLAY FUNCTION" on page 8.
- During recording, DEMO is not operative.
- The game Demo and the game sound are automatically canceled if the volume is adjusted while the unit is turned on.

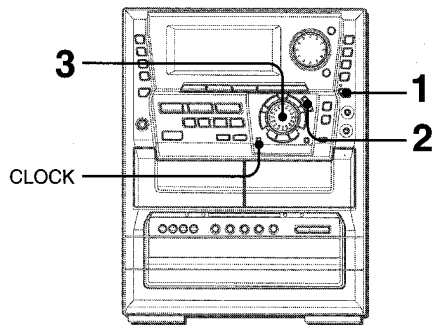

## AUDIO ADJUSTMENTS

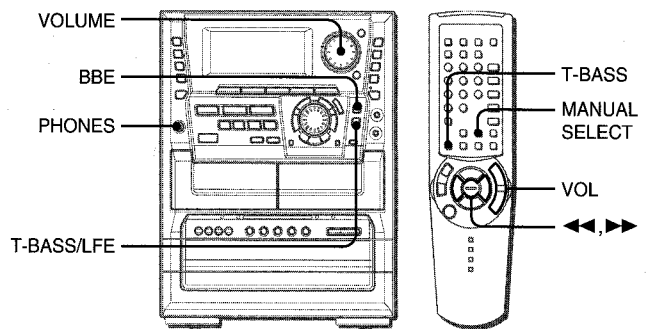

### VOLUME

Turn **VOLUME** on the main unit, or press **VOL** on the remote control.

The volume level is displayed as a number from 0 to MAX (50). The volume level is automatically set to 20 when the power is turned off with the volume level set to 21 or more.

#### To change the left/right balance

Press **MANUAL SELECT** on the remote control. L/R is displayed for 2 seconds. Press ◀ or ▶ on the remote control within these 2 seconds.

• The DOLBY PRO LOGIC (page 23), the DOLBY DIGITAL SURROUND (page 23) and the DSP SURROUND (page 12) front speakers level is also changed.

### BBE SYSTEM

The BBE system enhances the clarity of high-frequency sound. It also enriches the KARAOKE function to make your voice sound clear and pleasant.

#### Press BBE.

Each time it is pressed, the level changes. Select one of the three levels, or the off position to suit your preference.

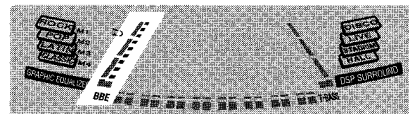

#### NOTE

- When playing back a tape recorded with BBE, it is recommended that BBE be set to off to avoid distorted high frequency sound.
- The BBE system is automatically canceled:
  - When the DIGITAL (Dolby Digital) mode is selected
  - When the Dolby Pro Logic is turned on
- The BBE system cannot be turned on and "Can'tUSE" is displayed:
  - While the DIGITAL (Dolby Digital) mode is selected
  - While the Dolby Pro Logic is turned on

### SETTING POWER ECONOMIZING MODE

Setting this unit power economizing mode reduces power consumption as follows.

- When the power is turned off, all the display lights turned off. However, if the clock is not set, the game Demo will begin when the power is turned off.
  - If CD, Tape or Rhythm play function (page 8) does not play for 10 minutes or if there is no audio input from any connected external equipment for 10 minutes when VIDEO 1/DVD/AUX (ANALOG) or VIDEO 2/LD/DVD (ANALOG) is selected as the source, the power shuts off.
  - When the power turns on due to timer recording (page 30), the display brightness level is set to "DIMMER 3" (page 6), all button lamps are off, and the volume is set to minimum level (0).
  - The display brightens only when operating the unit. When the unit has not been used for 10 seconds, the brightness level switches to the mode previously selected in "DIM MODE". (Page 6)
- (If the display brightness level is set to "DIM-OFF", the brightness does not change. When the level is "DIMMER 3", the button lamps are also turned off.)

#### 1 Press ECO.

"ECO MODE" will be displayed.

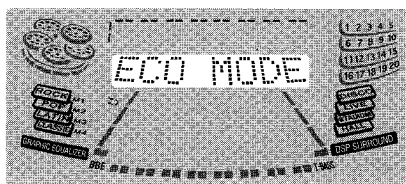

#### 2 Press ENTER within 4 seconds.

The current power-economizing mode status will be displayed. If the power-economizing mode is OFF: ECO OFF. If the power economizing mode is ON: ECO ON.

#### 3 Turn MULTI JOG within 4 seconds to switch the power-economizing mode on or off.

Example: When "ON" is selected.

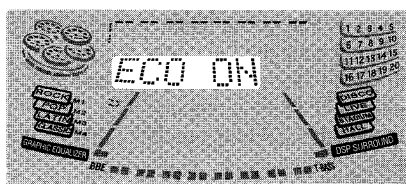

The mode will be automatically set after 4 seconds. It will also be set if **ENTER** is pressed within 4 seconds after step 3.

#### NOTE

To view the clock when all the display lights turn off, press **CLOCK** so that the time is displayed for 4 seconds.



## SUPER T-BASS SYSTEM

The T-BASS system enhances the realism of low-frequency sound.

### Press T-BASS/LFE.

Each time it is pressed, the level changes. Select one of the three levels, or the off position to suit your preference.

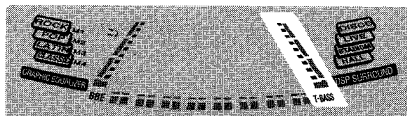

### NOTE

Low frequency sound may be distorted when the T-BASS system is used for a disc or tape in which low frequency sound is originally emphasized. In this case, cancel the T-BASS system.

## RHYTHM PLAY FUNCTION (BEAT MASTER DX)

### USING THE BEAT FUNCTION

This unit has a library of rhythms patterns from which you can select the desired one to add to the playback of any music sources, thus allowing you to create your original sounds. The mix created with the BEAT function can be recorded on tape if you want to. Also, the mix is available at **LINE OUT**.

### NOTE

The BEAT function is not available when making a tape copy between two tape decks using SYNC DUB.

### To select a rhythm pattern

**1 Press BEAT ON/OFF to switch the function on.**

One of the rhythm patterns is displayed.

**2 Turn MULTI JOG to select the desired rhythm pattern.**

The rhythm pattern is displayed cyclically as follows.



En

### Using the headphones

Connect headphones to **PHONES** with a stereo standard plug (ø6.3 mm, 1/4 inch).

No sound is output from the speakers while the headphones are plugged in.

- When the headphones are plugged in:
  - The Dolby Pro Logic or SURROUND system is automatically canceled
  - The Dolby Digital Surround mode is changed to the "2ch ST (2CH DOWNMIX)" mode

### NOTE

The Rhythm Play function is canceled when the DIGITAL (page 23) is selected.

These voice wave data incorporated in this product are Yamaha Corporation's copyrightable property and we are licensed by Yamaha Corporation.

## To adjust the tempo of the rhythm pattern

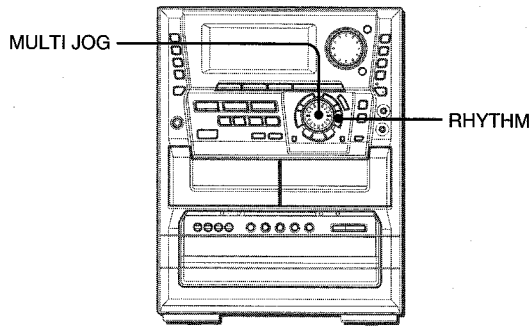

- 1 Press **RHYTHM** repeatedly until "Tempo XXX" is displayed.

### NOTE

If "AUTO" shows while you are pressing **RHYTHM**, change it to "MANUAL" by turning **MULTI JOG** to the left. In AUTO mode the tempo is automatically set and you cannot access the display of "Tempo".

- 2 Turn **MULTI JOG** to select the rhythm tempo.

The tempo can be changed from 81 to 160.

### NOTE

The tempo of GAME is not adjustable.

## To change the volume level of the rhythm pattern

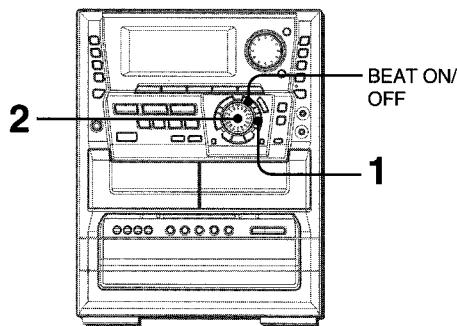

- 1 Press **RHYTHM** repeatedly until "LEVEL X" is displayed.

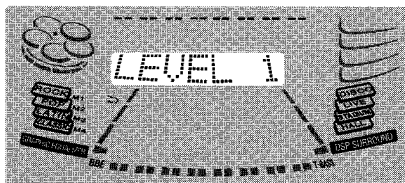

- 2 Turn **MULTI JOG**.

Three levels, 1–3, are available.

## To stop the BEAT function

Press **BEAT ON/OFF**.

BEAT toggles between On and Off.

### NOTE

When you interrupt or stop the playback of the sound source, the BEAT function is automatically switched off.

## Using the AUTO mode

The AUTO mode automatically adjusts the tempo of the current rhythm pattern so it coincides with the tempo of the music.

### NOTE

Depending on the music the AUTO mode may not work correctly (with songs whose tempo is fuzzy, or is varying, for example).

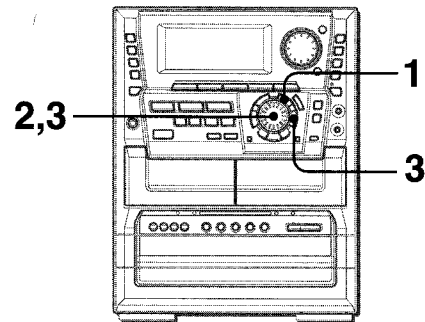

You can let the music start playing before performing step 1 or later at the desired moment.

- 1 Press **BEAT ON/OFF** to switch the function on.

You will hear the current rhythm pattern.

- 2 Turn **MULTI JOG** to select the desired rhythm pattern.

- 3 Press **RHYTHM** once while the selected rhythm pattern is displayed, then turn **MULTI JOG** to select "AUTO".

While the unit is trying to get synced up to the tempo of the music, a cascade-like indicator will flash on the sides of the graphic equalizer display section.

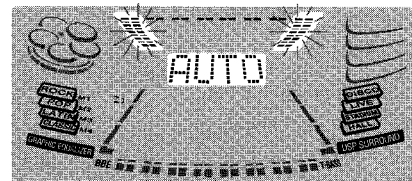

When the unit gets synced up to the tempo of the music, the display will momentarily read the synced-up tempo.

Depending on sound sources (such as, songs whose tempo is varying), however, you may see different tempos appearing one after the other in the display.

After one synced up, if the sync lock unlocks, the display will read "BEAT OUT", and again the unit will try to get synced up.

At the occurrence of BEAT OUT, the level of the rhythm is automatically reduced to "1"; and it increases back to the preset level when sync is achieved again.

### NOTE

The BEAT function can be used together with the SPICE A/B function, as well as with the FILL IN function. But the AUTO SPICE function cannot be used at the same time as the BEAT function.

## USING THE FILL IN FUNCTION

The FILL IN function is used together with the BEAT function to insert a variation of the current rhythm pattern.

The AUTO SPICE/FILL IN double function switch takes on the FILL IN function when the BEAT function is switched On.

### NOTE

- The AUTO SPICE function is not available at the same time as the FILL IN function.
- The FILL IN function is not available when making a tape copy between two tape decks using SYNC DUB.
- The FILL IN function is not available for the GAME rhythm.

### To use the FILL IN function

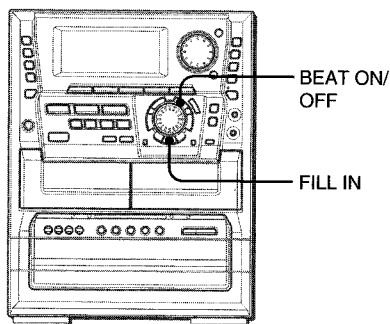

During playback with the BEAT function switched on, press FILL IN at the desired moment.

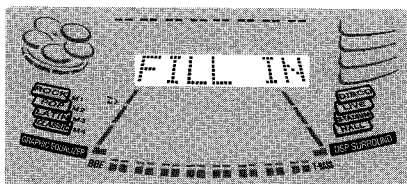

"FILL IN" is displayed and, when the current cycle of the rhythm pattern is over, you'll hear a short sound different from the rhythm pattern. This sound depends on the selected rhythm patterns.

## USING THE SPICE FUNCTION

### SPICE A/B function

The SPICE A/B function allows you to add percussion to the playback of the music and create your original sounds.

Your sounds created with SPICE A/B can be recorded on tape if you want to.

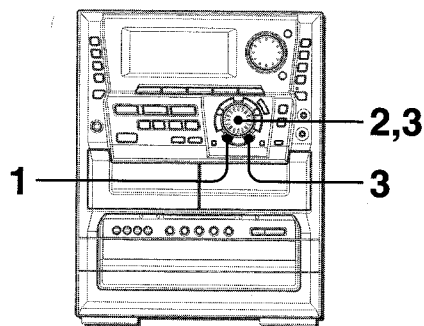

### 1 Press SPICE A.

You'll hear the current sound stored at A.

### 2 Within 4 seconds, turn MULTI JOG to select the desired sound.

As the display changes, you'll hear the respective sound.

### 3 In a similar way, select a sound for SPICE B.

### 4 Play the music source and hit SPICE A or B in time with the music as in playing percussion instruments.

### NOTE

The SPICE A/B function cannot be used when making a tape copy between two tape decks using SYNC DUB.

### Using the scratch mode

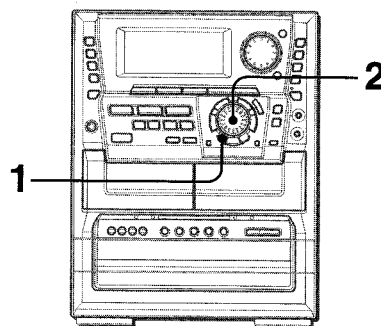

### 1 Hold down SPICE A. (Don't release the button until you complete step 2.)

"SCT MODE" is displayed.

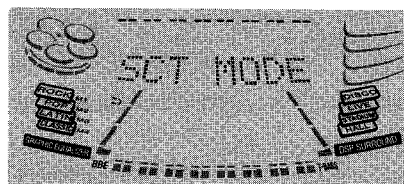

### 2 Still holding down the button, turn MULTI JOG.

Depending on the direction in which you turn MULTI JOG, different scratches are produced.

The Scratch mode is disabled when you release the A button.

## Using the AUTO SPICE function

The AUTO SPICE function produces the sounds of SPICE A and B in sync with the music, the sound of A in response to low frequency signals, and the sound of B in response to high frequency signals.

### NOTE

- The AUTO SPICE function cannot be used together with the BEAT function.
- Depending on the music, the AUTO SPICE function may not work the way you'd expect. In such a case, use the SPICE A/B function instead.
- The AUTO SPICE function is not available when making a tape copy between two tape decks using SYNC DUB.

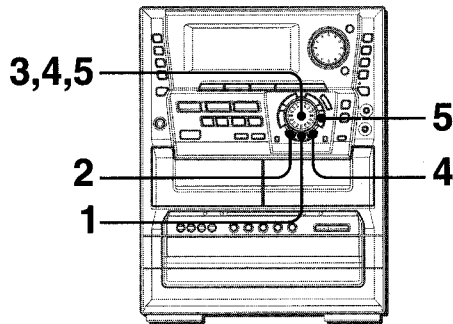

**1 Press AUTO SPICE to display "A-SPICE".**

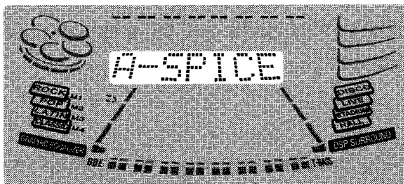

**2 Press SPICE A.**

You'll hear the sound currently stored in A, its name appearing in the display.

**3 While the sound name is displayed, turn MULTI JOG to select the desired sound.**

(Repeat step 2 if sound name disappears before turning MULTI JOG).

**4 Press SPICE B and repeat step 3 to select the desired sound for B.**

**5 To adjust the level of the A and B sounds, press RHYTHM repeatedly until "LEVEL X" is displayed, then turn MULTI JOG within 4 seconds.**

Three levels, 1, 2 and 3, are available.

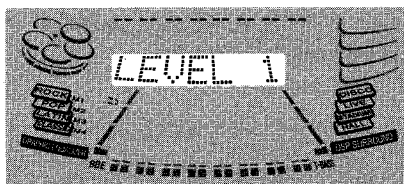

The level of A and B is adjusted simultaneously.

**6 Play the music source.**

The sound of SPICE A will play in sync with the bass, and the sound of SPICE B in sync with the treble.

## GRAPHIC EQUALIZER (GEQ)

### SELECTING THE PROGRAMMED EQUALIZATION CURVE

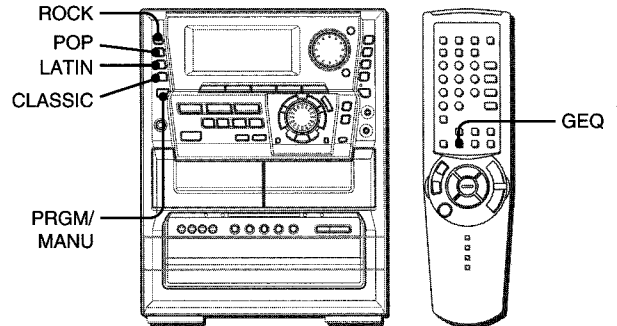

This unit provides four different programmed equalization curves.

**ROCK:** Powerful sound emphasizing treble and bass

**POP:** More presence in the vocals and midrange

**LATIN:** Accented higher frequencies for latin music

**CLASSIC:** Enriched sound with heavy bass and fine treble

Press PRGM/MANU so that one of the PRGM indicators is selected, and then press ROCK, POP, LATIN or CLASSIC.

PRGM indicators

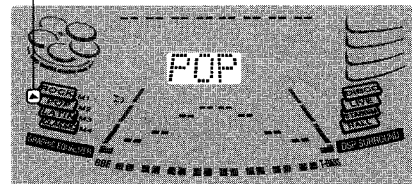

**To cancel the selected mode**

Press the selected button again. "GEQ OFF" is displayed.

**To select the equalization curve with the remote control**

Press GEQ repeatedly until the desired equalization curve is displayed.

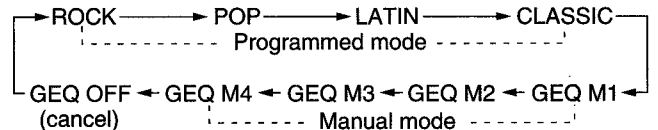

## SETTING NEW EQUALIZATION CURVES MANUALLY

Up to four equalization curves can be stored as the manual modes M1-M4.

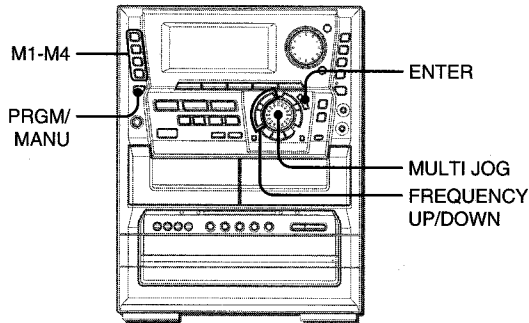

### 1 Press FREQUENCY UP or FREQUENCY DOWN to select a frequency.

The level indicator of the selected frequency flashes.

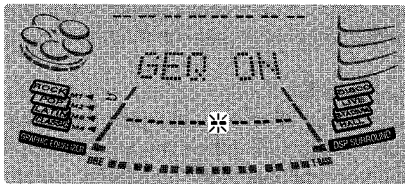

### 2 Turn MULTI JOG to adjust the level of the selected frequency.

### 3 Repeat steps 1 and 2 to make the desired equalization curve.

### 4 Within 4 seconds, press ENTER.

"MEMORY" is displayed for 8 seconds.

### 5 Within 8 seconds, press one of the graphic equalizer preset buttons M1-M4.

The equalization curve is stored.

The equalization curve has been memorized to M1.

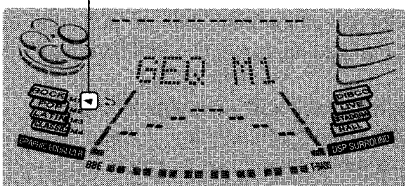

### To select a manual-preset GEQ

- 1 Press **PRGM/MANU** to select the manual mode. One of the **MANUAL** indicators is selected.
- 2 Press one of the graphic equalizer preset buttons **M1-M4**.

### To cancel the selected mode

Press the selected button again. "GEQ OFF" is displayed.

## DSP SURROUND

SOUND

The DSP (Digital Signal Processor) **SURROUND** adjusts the reverb level and delay time to give a resonant surround sound during playback, allowing you to enjoy the real sound presence of different environments.

This unit has been programmed with 4 different DSP **SURROUND** modes.

## SELECTING A PROGRAMMED DSP SURROUND MODE

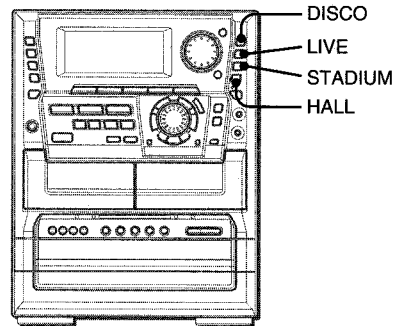

When you select the programmed DSP **SURROUND** mode, the sound presence of a disco (**DISCO**), live music performance (**LIVE**), stadium (**STADIUM**) or concert hall (**HALL**) can be obtained.

Press **DISCO**, **LIVE**, **STADIUM** or **HALL**.

En

DSP indicator

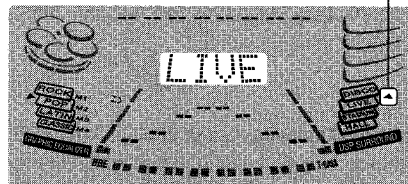

Equalization curves are selected automatically to match the DSP **SURROUND** modes and can also be selected or turned off to suit your preference.

### When the music source is monaural

Select **LIVE** or **STADIUM** to obtain a simulated stereo effect. When **DISCO** or **HALL** is selected, no sound will be heard from the surround speakers.

### To cancel the selected mode

Press the selected button again. "DSP OFF" is displayed.

### To select the DSP mode with the remote control

Press **SURROUND** repeatedly. The DSP mode is displayed cyclically as follows:

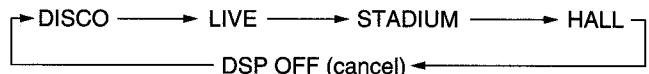

### NOTE

The DSP **SURROUND** mode is canceled when:

- the **ECHO** level is changed.
- the **DOLBY PRO LOGIC** is turned on.
- the headphones are plugged in.
- the **DIGITAL** (Dolby Digital) is turned on (except 2ch ST).

# BASIC OPERATIONS

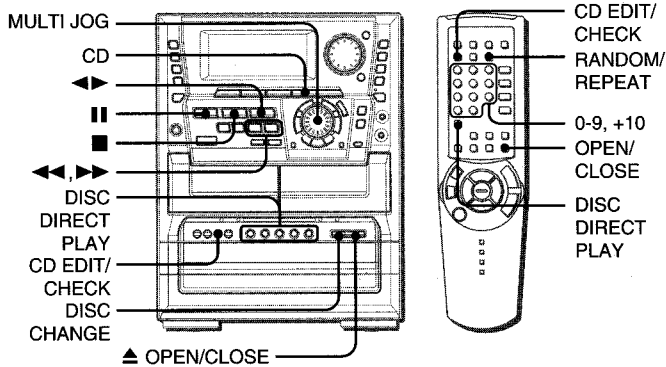

## LOADING DISCS

Press **CD**, then press **▲ OPEN/CLOSE** to open the disc compartment. Load disc (s) with the label side up.

To load one or two discs, place the disc(s) on the tray(s) in the direction of the arrows as illustrated.

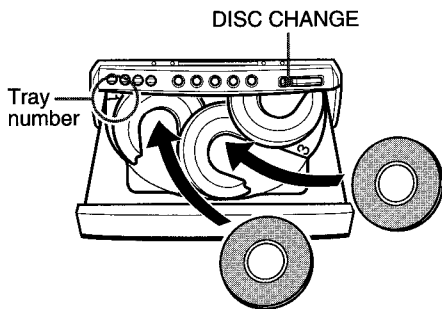

To load three to five discs, press **DISC CHANGE** to rotate the trays after placing two discs. Place the next disc on the empty tray. Each time **DISC CHANGE** is pressed, the trays rotate and one disc can be placed.

After placing the disc, press **▲ OPEN/CLOSE** to close the disc compartment.

The display shows the information of the disc to be played.

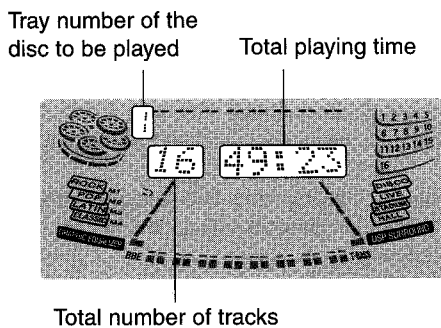

## PLAYING DISCS

Load discs.

To play all discs in the disc compartment, press **◀▶**.

All discs are played once.

Number of track being played Elapsed playing time

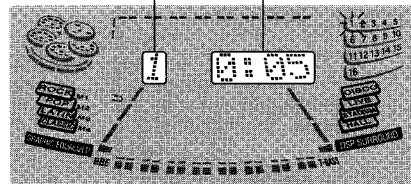

To play one disc only, press one of the **DISC DIRECT PLAY 1-5**.

The selected disc is played once.

To play with the remote control

Press **DISC DIRECT PLAY**, then press one of the numbered buttons 1-5 within 3 seconds to select a disc.

To stop play, press **■**.

To pause play, press **⏸**. To resume play, press again.

To search for a particular point during playback, keep **◀▶** or **▶▶** pressed and release it at the desired point.

To skip to the beginning of a track during playback, press **◀◀** or **▶▶** repeatedly or turn **MULTI JOG**.

To remove discs, press **▲ OPEN/CLOSE**.

You can only remove the two discs that face you. When the disc to be removed does not face you, press **DISC CHANGE** repeatedly.

To start play when the power is off (Direct Play Function)

Press **CD**. The power is turned on and play of the loaded disc(s) begins.

When **▲ OPEN/CLOSE** is pressed, the power is also turned on and the disc compartment is opened.

To check the remaining time

Press **CD EDIT/CHECK** during play. The amount of time remaining until all tracks finish playing is displayed. To restore the playing time display, press **CD EDIT/CHECK** again.

Selecting a track with the remote control

1 Press **DISC DIRECT PLAY**, then press one of the numbered buttons 1-5 within 3 seconds to select a disc.

2 Press numbered buttons **0-9** and **+10** to select a track.

Example:

To select the 25th track, press **+10, +10** and **5**.

To select the 10th track, press **+10** and **0**.

The selected track starts to play and play continues to the end of that disc.

Replacing discs during play

While one disc is playing, the other discs can be replaced without interrupting play.

1 Press **DISC CHANGE**.

Two discs can be replaced.

2 Remove the discs and replace with other discs.

To replace the other two discs, press **DISC CHANGE** again.

3 Press **▲ OPEN/CLOSE** to close the disc compartment.

**NOTE**

- While the disc compartment is opened with **DISC CHANGE**, do not press buttons other than **DISC CHANGE** or **▲ OPEN/CLOSE**. Doing so may cause malfunctions. In this case, reset the unit referring "To reset" on page 34.
  - When loading an 8-cm (3-inch) disc, make sure to put it onto the inner circle of the tray precisely. Otherwise, the disc may be damaged or the disc compartment will not open. If it does not open, please consult your Aiwa dealer for repair.
  - Do not use irregular shape CDs (example: heart-shaped, octagonal ones). It may result in malfunctions.
  - Do not place more than one compact disc on one disc tray.
  - Do not tilt the unit with discs loaded. Doing so may cause malfunctions.
  - When transporting the unit, remove the discs from the trays.
  - When replacing the discs during play, do not replace discs other than those facing you.
- If you place a disc on the empty right inner tray, and then press **▲ OPEN/CLOSE**, "ERROR" is displayed and the disc compartment may not close. Remove the disc on that tray.

Never place here.

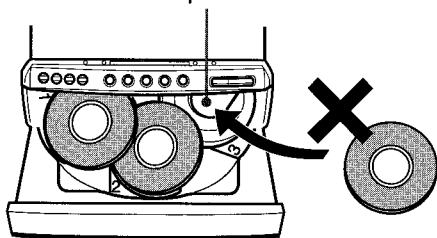

**RANDOM/REPEAT PLAY**

Use the remote control.

**RANDOM play**

All the tracks on the selected disc or on all the discs can be played randomly.

**REPEAT play**

A single disc or all the discs can be played repeatedly.

**Press RANDOM/REPEAT.**

Each time it is pressed, the function can be selected cyclically.

**RANDOM play** — RANDOM lights up on the display.

**REPEAT play** —  lights up on the display.

**RANDOM/REPEAT play** — RANDOM and  light up on the display

**Cancel** — RANDOM and  disappear from the display.

To play all discs, press  to start play.

To play a single disc, press **DISC DIRECT PLAY**, then press one of the numbered buttons 1-5 within 3 seconds to start play.

**NOTE**

During random play it is not possible to skip to the previously played track with the .

**BLANK SKIP PLAY**

The silent portions between tracks recorded on a CD can be skipped during playback.

**1 Press CD BLANK SKIP.**

"CD BLANK SKIP ON" is displayed and a small dot will appear in the display.

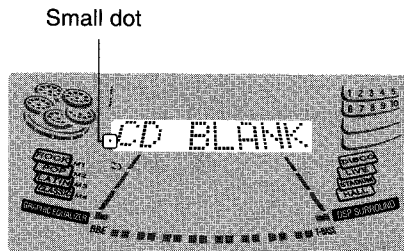

**2 Press  to start playback.**

The silent portions between tracks will be skipped, and the sound will be played back without interruption. If a track fades out (ends with the sound gradually decreasing), the fade-out portion also will be skipped.

**To return to normal playback**

Press **CD BLANK SKIP** again so that "CD BLANK SKIP OFF" is displayed, and the dot in the display will disappear.

**NOTE**

- There may be a case where BLANK SKIP PLAY does not function correctly.
- BLANK SKIP PLAY is automatically canceled when performing AI EDIT RECORDING (page 21), PROGRAMMED EDIT RECORDING (page 22), or PROGRAMMED PLAY recording (page 15) or RANDOM PLAY recording (page 14).

En

# PROGRAMMED PLAY

Up to 30 tracks can be programmed from any of the inserted disc.

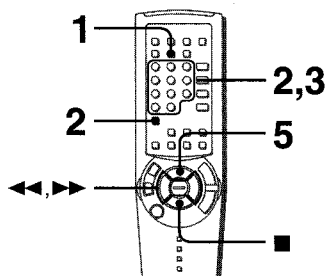

Use the remote control.

## 1 Press PRGM twice in stop mode.

PRGM indicator lights up on the display.

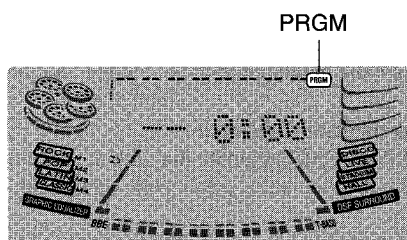

• When **PRGM** is pressed once in step 1, the unit enters KARAOKE PROGRAM (page 29).

## 2 Press DISC DIRECT PLAY, then press one of the numbered buttons 1-5 within 3 seconds to select a disc.

Go to the next step when the tray stops rotating.

## 3 Press the numbered buttons 0-9 and +10 to program a track.

Example:

To select the 25th track, press **+10**, **+10** and **5**.

To select the 10th track, press **+10** and **0**.

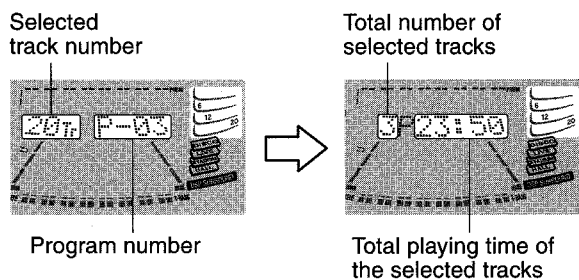

## 4 Repeat steps 2 and 3 to program other tracks.

## 5 Press ►/◄► to start play.

### To check the program

Each time ◀◀ or ▶▶ is pressed in stop mode, a disc number, track number, and program number will be displayed.

### To clear the program

Press ■ **CLEAR** in stop mode.

### To add tracks to the program

Repeat steps 2 and 3 in stop mode. The track will be programmed after the last track.

### To change the programmed tracks

Clear the program and repeat all the steps again.

### To play the programmed tracks repeatedly

After programming the tracks, press **RANDOM/REPEAT** repeatedly until ↺ appears on the display.

### NOTE

- During programmed play, you cannot perform random play, check the remaining time, and select a disc or track. "Can't USE" is displayed if you attempt to select a track or random play.
- "FULL" is displayed if you attempt to program more than 30 tracks.



## MANUAL TUNING

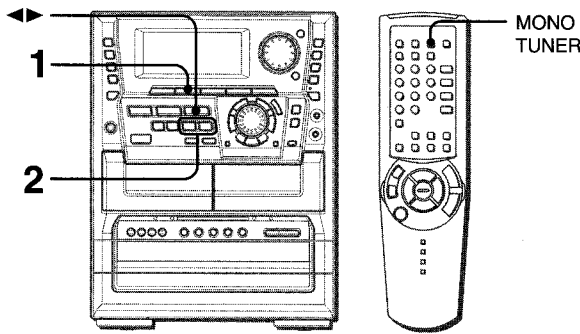

### 1 Press TUNER/BAND repeatedly to select the desired band, FM or AM.

When TUNER/BAND is pressed while the power is off, the power is turned on directly.

### 2 Press ◀◀ DOWN or ▶▶ UP to select a station.

Each time the button is pressed, the frequency changes. When a station is received, "TUNE" is displayed for 2 seconds. During FM stereo reception, ((Ⓜ)) is displayed.

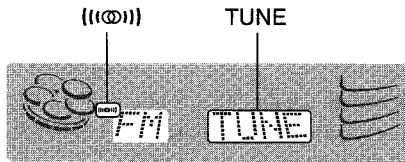

### To search for a station quickly (Auto Search)

Keep ◀◀ DOWN or ▶▶ UP pressed until the frequency starts to change rapidly. After tuning in to a station, the search stops. To stop the Auto Search manually, press ◀◀ DOWN or ▶▶ UP.

- The Auto Search may not stop at stations with very weak signals.

### When an FM stereo broadcast contains noise

Press MONO TUNER on the remote control so that "MONO" appears on the display.

Noise is reduced, although reception is monaural.

To restore stereo reception, press the button again so that MONO disappears.

### To change the AM tuning interval

The default setting of the AM tuning interval is 10 kHz/step. If you use this unit in an area where the frequency allocation system is 9 kHz/step, change the tuning interval.

Press POWER while pressing ◀▶.

To reset the interval, repeat this procedure.

### NOTE

When the AM tuning interval is changed, all preset stations are cleared. The preset stations have to be set again.

## PRESETTING STATIONS

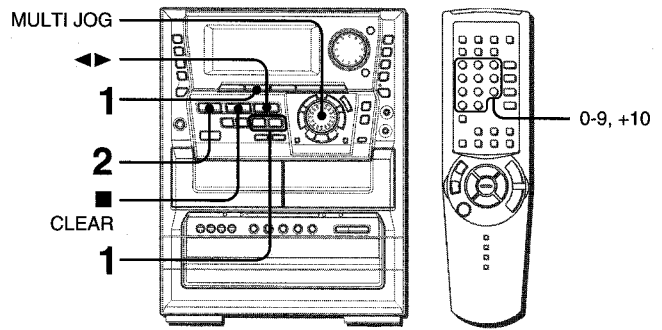

The unit can store a total of 32 preset stations. When a station is stored, a preset number is assigned to the station. Use the preset number to tune in to a preset station directly.

### 1 Press the TUNER/BAND to select a band, and press ◀◀ DOWN or ▶▶ UP to select a station.

### 2 Press ■ SET to store the station.

A station is assigned a preset number, beginning from 1 in consecutive order for each band.

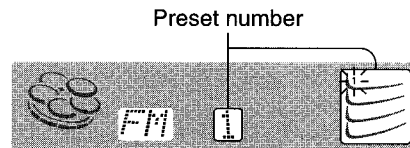

### 3 Repeat steps 1 and 2.

The next station will not be stored if a total of 32 preset stations for all the bands have already been stored.

### NOTE

"FULL" is displayed if you attempt to store more than 32 preset stations.

## PRESET NUMBER TUNING

Use the remote control to select the preset number directly.

### 1 Press TUNER/BAND to select a band.

### 2 Press numbered buttons 0-9 and +10 to select a preset number.

Example:

To select preset number 15, press +10 and 5 .

To select preset number 20, press +10, +10 and 0.

### Selecting a preset number on the main unit

Press TUNER/BAND to select a band. Then, press ◀▶ repeatedly or turn MULTI JOG.

Each time ◀▶ is pressed, the next higher number is selected.

### To clear a preset station

Select the preset number of the station to be cleared. Then, press ■ CLEAR, and press ■ SET within 4 seconds.

The preset numbers of all other stations in the band with higher numbers are also decreased by one.

**BASIC OPERATIONS**

**INSERTING TAPES**

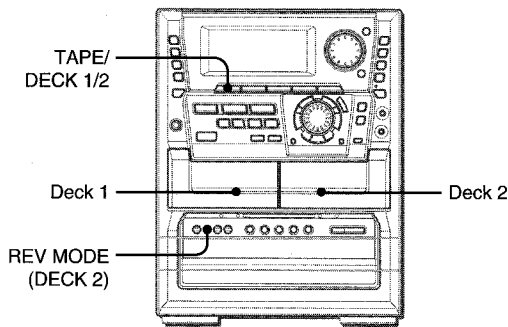

- On deck 1, tapes are always played back on both sides.  
On deck 2, you can select a reverse mode to play back one or both sides.
- Use Type I (normal), Type II (high/CrO<sub>2</sub>) or Type IV (metal) tapes for playback.

Press **TAPE/DECK 1/2**, then press **▲ PUSH EJECT** to open the cassette holder.

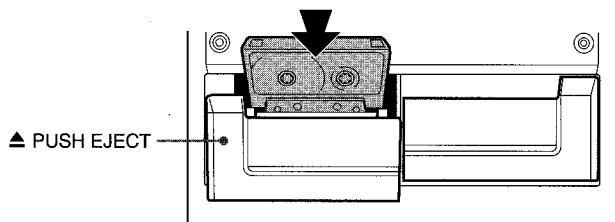

Insert a tape with the exposed side down. Push the cassette holder to close.

**To select a reverse mode (deck 2 only)**

Each time **REV MODE(DECK 2)** is pressed, the reverse mode changes.

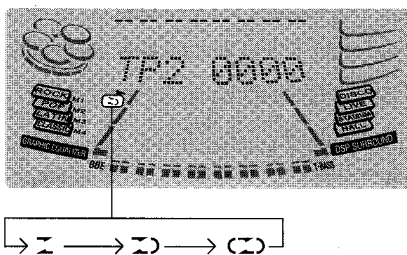

- To play one side only, select **I**.
- To play from front side to reverse side once only, select **II**.
- To play both sides repeatedly, select **III**.
- When tapes are loaded in both decks, **III** on the display indicates Continuous Play.

**PLAYING BACK A TAPE**

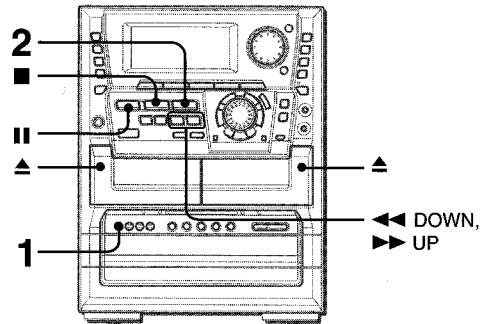

Insert a tape.

**1 Press DOLBY NR** to turn Dolby NR on or off to match the playback tape.

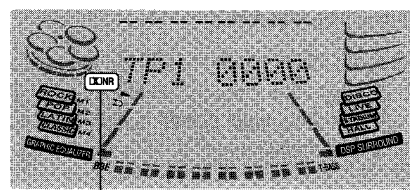

**DN NR**

For tapes recorded with DOLBY NR, turn on **DN NR**.  
For tapes recorded without DOLBY NR, turn off **DN NR**.

**2 Press ◀▶** to start play.

Playing deck number

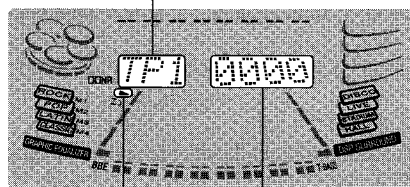

Playback side of the tape      Tape counter

- ▶: The front side is being played (forward).
- ◀: The back side is being played (reverse).

**When tapes are loaded in both decks**

Press **TAPE/DECK 1/2** first to select a deck. The selected deck number is displayed.

**To stop play, press ■.**

**To pause play (deck 2 only), press III.** To resume play, press again.

**To change the playback side, press ◀▶ DIRECTION/PRESET** in play or pause mode.

**To fast forward or rewind, press ◀◀ or ▶▶** in stop mode. Then press **■** to stop the tape.

**To start play when the power is off (Direct Play Function)**

Press **TAPE/DECK 1/2**. The power is turned on and play of the inserted tape begins.

**To set the tape counter to 0000**

Press **■ CLEAR** in stop mode.

The counter is also set to 0000 when the cassette holder is opened.

## MUSIC SENSOR

If there is a 4-second or longer blank between each track, a search for the beginning of the current or next track during playback can be done easily.

**When ► of ◀► button is flashing,** press ►► to move to the next track or ◀◀ to move to the beginning of the current track.

**When ◀ of ◀► button is flashing,** press ◀◀ to move to the next track, or ►► to move to the beginning of the current track.

The search function may not be able to detect tracks under the following conditions:

- Blanks of less than 4 seconds between tracks
- Noisy blanks
- Long passages of low-end sound
- Low overall recording levels

## CONTINUOUS PLAY

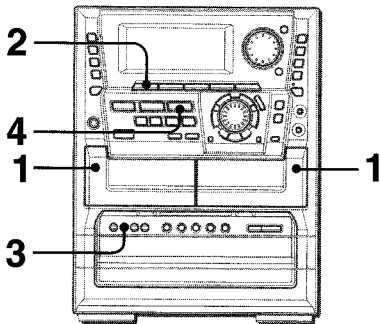

After playback on one deck finishes, the tape in the other deck will start to play without interruption.

- 1 Insert tapes into deck 1 and deck 2.**
- 2 Press TAPE/DECK1/2 to select the deck to be played back first.**
- 3 Press REV MODE(DECK 2) to select 2.**
- 4 Press ◀► to start playback.**  
Playback continues until ■ is pressed.

### About cassette tapes

- **To prevent accidental erasure,** break off the plastic tabs on the cassette tape after recording with a screwdriver or other pointed tool.

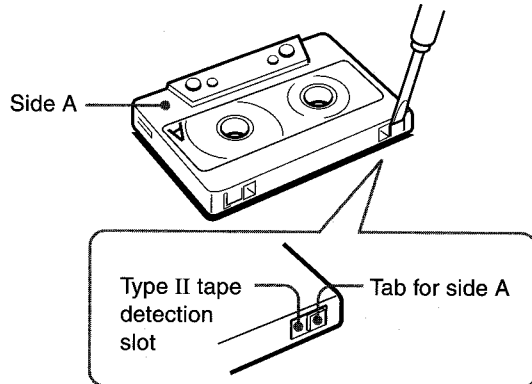

To record on the tape again, cover the tab openings with adhesive tape, etc. (On Type II tapes, take care not to cover the Type II tape detection slot.)

- **120-minute or longer tapes** are extremely thin and easily deformed or damaged. They are not recommended.
- **Take up any slack in the tape** with a pencil or similar tool before use. Slack tape may break or jam in the mechanism.

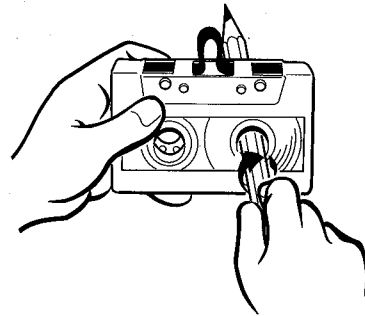

### DOLBY NR system

The Dolby Noise Reduction system reduces tape hiss noise. For optimum performance when playing back a tape recorded with the DOLBY NR system, turn on the DOLBY NR system.

# BASIC RECORDING

This section explains how to record from the tuner, CD player, or external equipment.

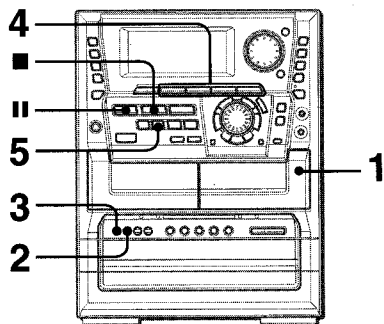

**Preparation**

- Set the tape to the point where recording will start.
- Use Type I (normal) and Type II (high/CrO<sub>2</sub>) tapes for recording.

**1 Insert the tape to be recorded on into deck 2.**

Insert the tape with the side to be recorded on first facing out from the unit.

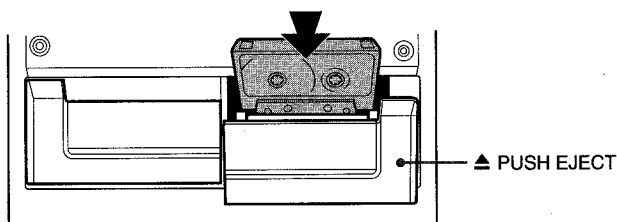

**2 Press REV MODE(DECK 2) to select the reverse mode.**

To record on one side only, select .  
To record on both sides, select or

**3 Press DOLBY NR to turn Dolby NR on or off.**

To record with DOLBY NR, turn on NR.  
To record without DOLBY NR, turn off NR.

**4 Press function (CD, TUNER/BAND, VIDEO 1/DVD/AUX or VIDEO 2/LD/MD) and prepare the source to be recorded.**

To record from a CD, press CD and load the disc(s).  
To record from a radio broadcast, press TUNER/BAND and tune in to a station.  
To record from a connected source, press VIDEO 1/DVD/AUX or VIDEO 2/LD/MD.

**5 Press ● REC/REC MUTE to start recording.**

When recording from a connected source, start playback of the source.

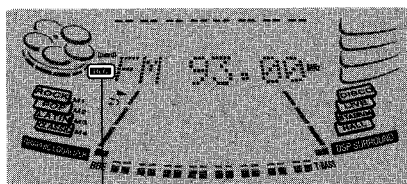

**REC**

When the selected function is CD, playback and recording start simultaneously.

To stop recording, press .

To pause recording, press . (Applicable when the source is TUNER/BAND, VIDEO 1/DVD/AUX or VIDEO 2/LD/MD.) To resume recording, press again.

**To start recording with the remote control**

First press /O REC/REC MUTE, and then press within 2 seconds.

## SOUND ADJUSTMENT DURING RECORDING

The output volume of the speakers or headphones may be freely varied without affecting the level of the recording. But BBE and Rhythm play function (BEAT, AUTO SPICE/FILL IN, SPICE A/B) will affect the recording.

**Recording with BBE**

The desired source can be recorded with the BBE function to enhance the clarity of high-frequency sound. When playing back a tape recorded with BBE, it is recommended that BBE be set to off.

## INSERTING BLANK SPACES

Insertion of 4-second blank spaces enables you to activate the Music Sensor function. (Applicable when the source is TUNER, VIDEO 1/DVD/AUX or VIDEO 2/LD/MD.)

**1 Press ● REC/REC MUTE during recording or while in recording pause mode.**

on the display flashes for 4 seconds and the tape runs without recording. After 4 seconds, the deck enters the recording pause mode.

**2 Press to resume recording.**

To insert a blank space of less than 4 seconds, press ● REC/REC MUTE again while is flashing.

To insert blank spaces of more than 4 seconds, after the deck enters recording pause mode, press ● REC/REC MUTE again. Each time the button is pressed, a 4-second blank space is added.

**NOTE**

"Can't REC" is displayed if you attempt to record on a tape with the plastic tabs broken off.

**To erase a recording**

Make sure the microphone(s) is(are) not connected to this unit and set the microphone volume and the echo level to OFF. (page 27). Also, check to make sure that BEAT and AUTO SPICE are switched off (page 8).

- 1 Insert the tape to be erased into deck 2 and press TAPE/DECK 1/2 to display "TP 2".
- 2 Set the tape to the point where the erasure is to be started.
- 3 Set the reverse mode by pressing REV MODE (DECK 2).
- 4 Press ● REC/REC MUTE to start the erasure.

## DUBBING A TAPE MANUALLY

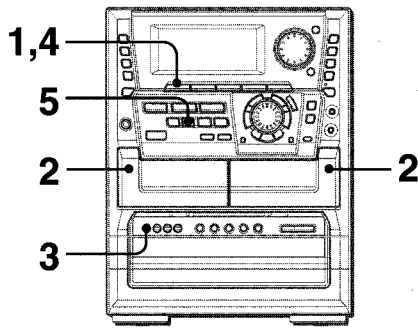

### Preparation

- Set the tape to the point where recording will start.
- The reverse mode is automatically set to  $\Sigma$ . Note that recording will be done on one side of the tape only.

#### 1 Press TAPE/DECK 1/2.

#### 2 Insert the original tape into deck 1 and the tape to be recorded on into deck 2.

Insert the tapes with the sides to be played back or recorded on facing out from the unit.

#### 3 Press DOLBY NR to turn off the Dolby NR.

$\square\square$  NR on the display goes out.

#### 4 Press TAPE/DECK 1/2 to select deck 1.

"TP1" is displayed.

#### 5 Press $\bullet$ REC/REC MUTE to start recording.

Playing and recording start simultaneously.

### To stop dubbing

Press  $\blacksquare$ .

### To set the Dolby NR when playing back the dubbed tape

Press DOLBY NR and turn Dolby NR on or off to match the original tape.

## DUBBING THE WHOLE TAPE

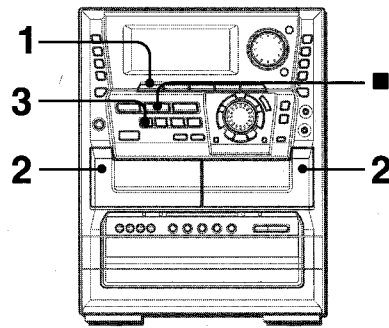

RECORDING

This function allows you to make exact copies of both sides of the original tape. The reverse side of both tapes will start simultaneously as soon as the longer tape has been reversed.

### NOTE

- Dubbing does not start from a point halfway in the tape.
- The reverse mode is automatically set to  $\Sigma$ .
- The Dolby NR does not affect recording.

#### 1 Press TAPE/DECK 1/2.

#### 2 Insert the original tape into deck 1 and the tape to be recorded on into deck 2.

Insert each tape with the side to be played back or recorded on first facing out from the unit.

#### 3 Press SYNC DUB once or twice to start recording.

- ① For recording at normal speed, press it once to display "NORM-DUB".
- ② For recording at high speed, press it twice to display "HIGH-DUB".

①

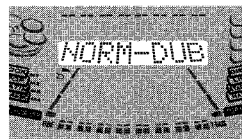

②

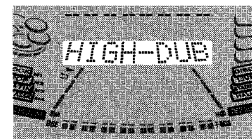

The tapes are rewound to the beginning of the front sides, and recording starts.

### To stop dubbing

Press  $\blacksquare$ .

### To set the Dolby NR when playing back the dubbed tape

Press DOLBY NR and turn Dolby NR on or off to match the original tape.

### NOTE

- Recording does not start, if the erasure prevention tab on either side of the tape is broken off.
- If the leader segment of the tape to be recorded on is longer than that of the original tape, recording on the reverse side may stop midway through the recording. In this case, dub each side manually following the procedure in "DUBBING A TAPE MANUALLY".

En

### COPYRIGHT

Please check the laws on copyright relating to recordings from discs, radio or external tape for the country in which the machine is being used.

# AI EDIT RECORDING

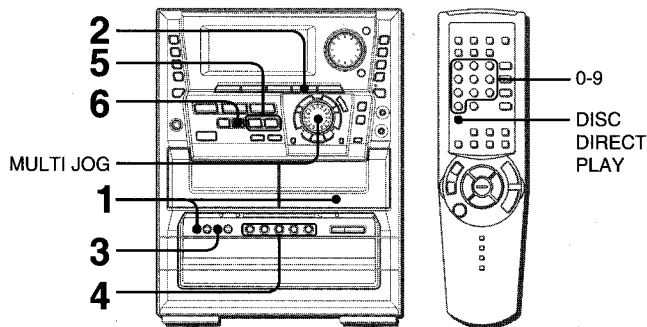

The AI edit recording enables CD recording without worrying about tape length and track length. When a CD is inserted, the unit automatically calculates the total track length. If necessary, the order of tracks is rearranged so that no track is cut short. (AI: Artificial Intelligence)

## NOTE

AI edit recording will not start from a point halfway into the tape. The tape must be recorded from the beginning of either side.

### 1 Insert the tape into deck 2, and press DOLBY NR to turn Dolby NR on or off.

Insert the tape with the side to be recorded on first facing out from the unit.

### 2 Press CD and load the disc(s).

### 3 Press CD EDIT/CHECK once.

"EDIT" lights up and "AI" flashes on the display.

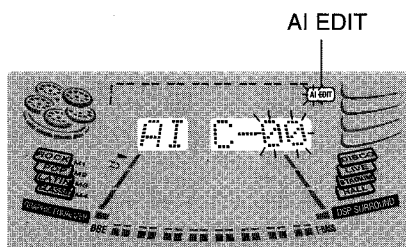

When "PRGM" is displayed, press CD EDIT/CHECK again.

### 4 Press one of the DISC DIRECT PLAY 1-5 to select a disc.

### 5 Press ◀ or ▶ to designate the tape length.

10 to 99 minutes can be specified.

In a few seconds, the tracks to be recorded on each side of the tape are determined.

- The numbered buttons **0-9** or **MULTI JOG** are also available to designate the tape length.

*Example:* When using a 60-minute tape, press **6** and **0**.

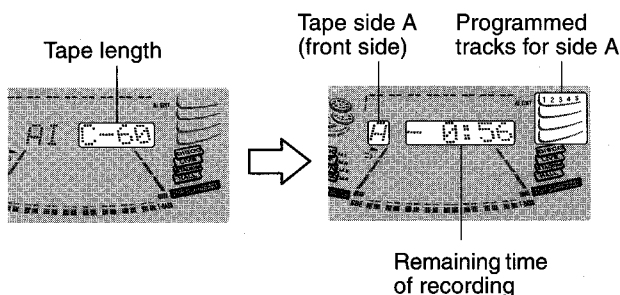

### 6 Press ● REC/REC MUTE to start recording.

The tape is rewound to the beginning of the front side, the lead segment is played through for 10 seconds, and recording starts. When recording on the front (side A) ends, recording on the back (side B) starts.

### To stop recording

Press ■. Recording and CD play stop simultaneously.

### To clear the edit program

Press ■ **CLEAR** twice so that "EDIT" disappears on the display.

### To check the order of the programmed track numbers

Before recording, press **CD EDIT/CHECK** to select side A or B, and press ◀ or ▶ repeatedly or turn **MULTI JOG**.

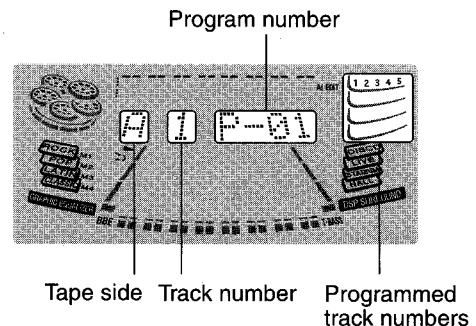

### To add tracks from other discs to the edit program

If there is any time remaining on the tape after step 5, you can add tracks from other discs in the CD compartment.

#### 1 Press CD EDIT/CHECK to select side A or B.

#### 2 Press one of the DISC DIRECT PLAY 1-5 to select a disc.

#### 3 Press the numbered buttons on the remote control to select tracks.

A track which has a playing time longer than the remaining time cannot be programmed.

#### 4 Repeat steps 2 and 3 to add more tracks.

### Time on cassette tapes and editing time

The actual cassette recording time is usually a little longer than the specified recording time printed on the label. This unit can program tracks to use the extra time. When the total recording time is a little longer than the tape's specified recording time after editing, the display shows the extra time (without a minus mark), instead of the time remaining on the tape (with the minus mark).

## NOTE

- Recording is inhibited if the erasure prevention tab on either side of the tape is broken off.
- The AI edit recording function cannot be used with discs containing 31 tracks or more. "TR OVER" is displayed if this is attempted.

# PROGRAMMED EDIT RECORDING

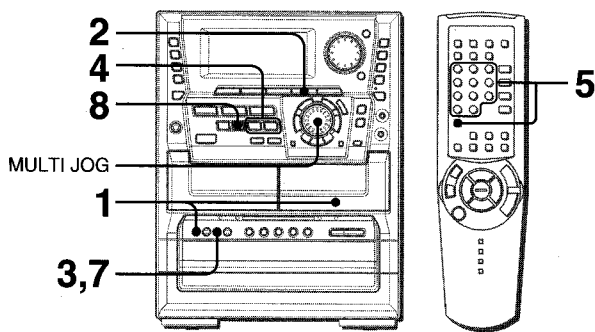

In the programmed edit recording function, the tracks can be programmed while checking the remaining time on each side of the tape.

## NOTE

The programmed edit recording will not start from a point halfway in the tape. The tape must be recorded from the beginning of either side.

### 1 Insert the tape into deck 2, and press DOLBY NR to turn Dolby NR on or off.

Insert the tape with the side to be recorded on first facing out from the unit.

### 2 Press CD and load the disc(s).

### 3 Press CD EDIT/ CHECK twice.

"EDIT" lights up and "PRGM" flashes on the display.

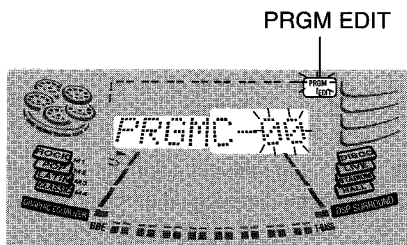

When "AI" is displayed, press CD EDIT/CHECK again.

### 4 Press ◀ or ▶ to designate the tape length.

10 to 99 minutes can be specified.

- The numbered buttons 0-9 or MULTI JOG are also available to designate the tape length.

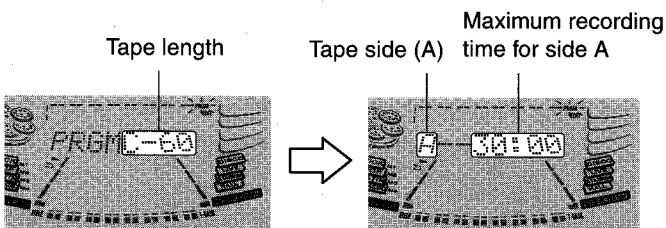

### 5 Press DISC DIRECT PLAY, then press numbered buttons 1-5 within 3 seconds on the remote control to select a disc. Then press numbered buttons 0-9 and +10 to program a track.

Example: To select the 10th track of disc 2, press DISC DIRECT PLAY and 2, then press +10 and 0.

### 6 Repeat step 5 for the rest of the tracks for side A.

A track whose playing time is longer than the remaining time cannot be programmed.

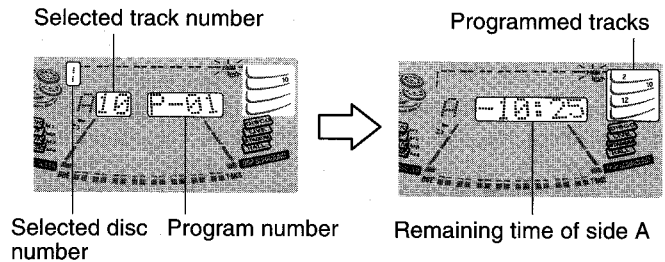

### 7 Press CD EDIT/CHECK to select side B and program the tracks for side B.

After confirming B on the display, repeat step 5.

Tape side B (reverse side)

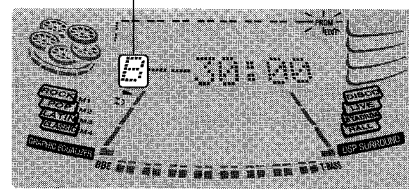

### 8 Press ● REC/REC MUTE to start recording.

The tape is rewound to the beginning of the front side, the lead segment is played through for 10 seconds, and recording starts. When recording on the front side (A) ends, recording on the back side (B) starts.

### To stop recording

Press ■. Recording and CD play stop simultaneously.

### To check the order of the programmed track numbers

Before recording, press CD EDIT/CHECK to select side A or B, and press ◀ or ▶ repeatedly or turn MULTI JOG.

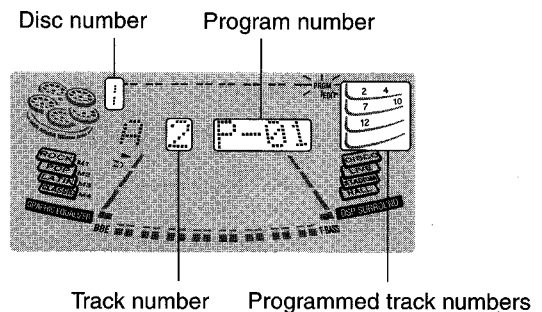

### To change the program of each side

Press CD EDIT/CHECK to select side A or B, and press ■ CLEAR to clear the program of the selected side. Then program tracks again.

### To clear the edit program

Press ■ twice so that "EDIT" disappears on the display.

## NOTE

- Recording is inhibited if the erasure prevention tab on either side of the tape is broken off.
- Up to 30 tracks can be programmed from any of the inserted discs.
- "FULL" is displayed if you attempt to program more than 30 tracks.

RECORDING

En

## DOLBY SURROUND

This unit is equipped with not only the Dolby Pro Logic decoder but also Dolby Digital decoder.

The unit and the center and surround speakers (standard) assure full-scale home theater sound. When playing back discs or video software that have been recorded in Dolby Pro Logic or Dolby Digital Surround, astonishingly realistic sound surrounds the listener to create a new level of audio/visual entertainment.

Independent control of the five sound channels allows the listener to enjoy the same type of sound reproduction experienced in movie theaters. Voices are reproduced in the front and center sound field, while ambient sounds like cars and crowds are reproduced on all sides of the listener for an incredibly lifelike audio/video experience. Please read the following carefully to "tune" the system's output to match the characteristics of your listening space.

### Check the following:

- Before enjoying the **DOLBY SURROUND** sound, adjust the speaker sound levels to the proper balance (see page 24).
- Make sure the supplied speakers are properly connected and positioned. (See page 3)
- Make sure the TV set and video unit are properly connected. (See page 4)
- Make sure the disc and video tape, etc., support Dolby Pro Logic or Dolby Digital Surround.

## SELECTING DOLBY SURROUND

The optimal Dolby Digital Surround and Dolby Pro Logic modes and settings depend on the type and placement of the speakers. Check the current type and placement of your speakers and select the recommended mode accordingly.

### The recommended mode

#### [Dolby Digital Surround]

	Center speaker		
	Larger-size (optional)	Smaller-size (supplied)	No speaker connected
Surround speaker (Rear speaker)	DOLBY D-WIDE	DOLBY D-NORMAL	PHANTOM
No surround speaker	3 STEREO-WIDE	3 STEREO-NORMAL	2chSTEREO

#### [Dolby Pro Logic]

	Center speaker		
	Larger-size (optional)	Smaller-size (supplied)	No speaker connected
Surround speaker (Rear speaker)	PRO LOGIC-WIDE	PRO LOGIC-NORMAL	PHANTOM
No surround speaker	3 STEREO-WIDE	3 STEREO-NORMAL	Pro Logic off

**PHANTOM mode:** Use this mode when no center speaker is connected. The center channel signals are output through the left and right speakers.

**3 STEREO mode:** Use this mode when no surround speakers are connected. This mode reproduces rear sounds through the front speakers.

## TO SELECT A DOLBY SURROUND MODE

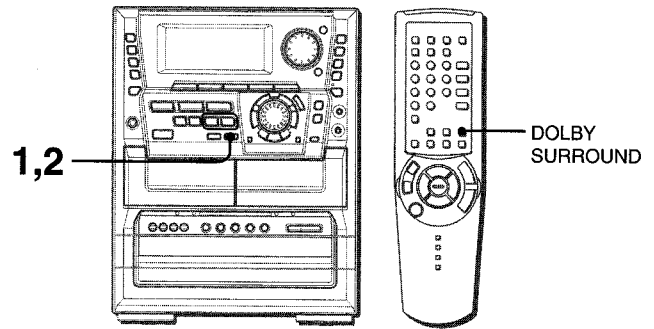

- When selecting a Dolby Digital Surround mode, select the VIDEO 1 (DIGITAL) or VIDEO 2 (DIGITAL) function and play a disc recorded in Dolby Digital Surround before selecting the mode.
- To select "DIGITAL" or "ANALOG" mode, see step 1 of "TO PLAY A DVD OR LD RECORDED IN DOLBY DIGITAL SURROUND" (page 33)

### 1 Press DOLBY SURROUND repeatedly to select the appropriate mode.

The selected mode name appears on the display.

#### [Dolby Digital Surround]

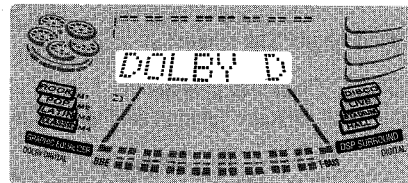

To select the 2chSTEREO mode, press the DOLBY SURROUND button repeatedly until "2ch ST" appears.

#### NOTE

Select the Dolby Digital Surround mode after playing a source recorded in Dolby Digital Surround.

The Dolby Digital Surround mode cannot be selected:

- When using the unit for the first time
- When playing discs not recorded in Dolby Digital Surround.

#### [Dolby Pro Logic]

When selecting a Dolby Pro Logic mode, select the function except VIDEO 1 (DIGITAL) and VIDEO 2 (DIGITAL).

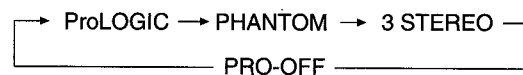
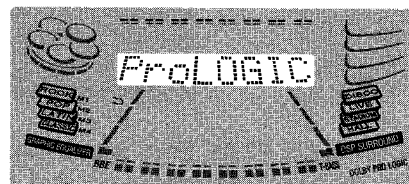



**2 Press the DOLBY SURROUND button again and hold it down until the center speaker mode to be selected appears. (Except the 2ch ST and PHANTOM modes.)**

“NORMAL” and “WIDE” appear one after the other.

**To select Dolby Pro Logic mode for 2ch DOLBY DIGITAL signal**

- For Pro Logic encoded signal:  
Press **DOLBY SURROUND** once.
- For non-Pro Logic encoded signal:  
When the selected Dolby Digital Surround mode is 2ch ST, press **DOLBY SURROUND** once.  
When the selected Dolby Digital Surround mode is not 2ch ST, press **DOLBY SURROUND** twice.

**NOTE**

- Depending on the sound source or listening condition, surround effect may not be obtained even when the Dolby Digital Surround or Dolby Pro Logic is selected.
- The full Dolby Digital Surround or Dolby Pro Logic effect cannot be obtained when using software not recorded in the Dolby Digital Surround or Dolby Pro Logic system. In this case, use the DSP surround system instead (see page 12).
- When headphones are plugged in:
  - the Dolby Pro Logic system is automatically canceled.
  - the Dolby Digital Surround mode is automatically changed to “2ch ST”.
- While headphones are plugged in:
  - the Dolby Pro Logic cannot be turned on.
  - the Dolby Digital Surround mode cannot be changed.
- “Can’tUSE” is displayed when Dolby Digital Surround (except 2ch ST) or Dolby Pro Logic is selected and the following functions are attempted.
  - the ECHO level is changed.
  - the SURROUND system or BBE is turned on.
  - the Karaoke function is turned on.

**ADJUSTING SPEAKER LEVEL BALANCE**

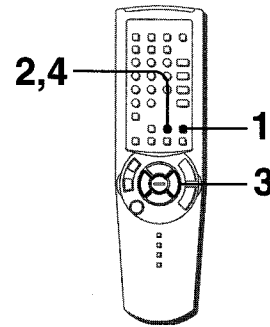

The unit is equipped with a built-in test signal generator called a noise sequencer for easy balance adjustment of all five channels. The sequencer outputs a noise signal that “travels” from channel to channel, enabling the simple adjustment of sound level to achieve, at the listening position, the same apparent loudness from each channel.

**About the channels**

**The left and right front speakers** create the stereo effect.  
**The center speaker** helps achieve precise sound positioning over a broad sound field.  
**The rear-mounted surround speakers** enhance the “depth” of the sound field.

Use the remote control from step 2 to 4.

**1 Select the Dolby Digital Surround (except “2ch ST”) or Dolby Pro Logic mode according to the current type and placement of your speakers.**  
 (See page 23.)

**2 Press MANUAL SELECT and hold it down for about four seconds until “L” flashes.**

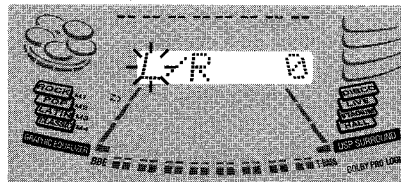

A noise signal is sent to each channel in turn in the following sequence.

**DOLBY D (PRO LOGIC) NORMAL or WIDE mode**

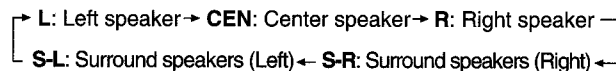

En

To be continued

## PHANTOM mode

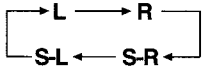

## 3 STEREO NORMAL or WIDE mode



### 3 Adjust the sound level of the center and the surround speakers.

While "CEN" or "S-R" or "S-L" is displayed, press ◀◀ or ▶▶ to adjust the volume of the center or each surround speaker to match the level of the front speakers.

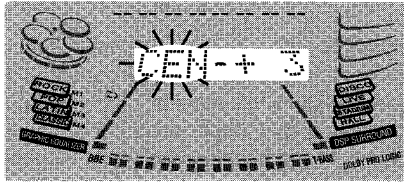

To adjust the balance between the left and right front speakers, see page 7.

### 4 Press MANUAL SELECT again to stop the noise signal.

#### NOTE

- If the surround speakers or the center speaker level of the DOLBY PRO LOGIC is changed, that of the SURROUND system (page 12) and the DOLBY DIGITAL SURROUND (page 30) are also changed.
- When the sequencer outputs a noise signal, a clicking sound might be heard from the speakers due to the characteristics of the circuit. This is not malfunction.

### To change the delay time of the surround speakers or center speaker when using the Dolby Digital Surround or Dolby Pro Logic mode

While the Dolby Digital Surround (except "2ch ST") or Dolby Pro Logic is activated, press **MANUAL SELECT** on the remote control repeatedly so that "CEN 0mS" or "SUR 5mS" (SUR 20mS) is displayed. Then, within 4 seconds, press ◀◀ or ▶▶ on the remote control. The delay time changes as shown below.

#### [Center speaker]

Adjust the delay time so that lines (voice in a movie) are heard clearly and naturally.

The center speaker delay time is initially set to 0 ms (milliseconds). It can be adjusted between 0 and 5 ms in 1 ms step.

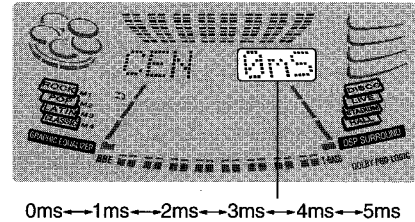

#### [Surround speaker]

Adjust the delay time to suit your preference.

#### Dolby Digital Surround

The speakers delay time is initially set to 5 ms. It can be adjusted between 0 and 15 ms in 5 ms steps.

#### Dolby Pro Logic

The speakers delay time is initially set to 20 ms. It can be adjusted between 15 and 30 ms in 5 ms steps.

#### NOTE

- When adjusting the delay time of the surround speakers or center speaker for the Dolby Digital Surround, that of the Dolby Pro Logic is changed and vice versa.
- When the surround speakers delay time of the Dolby Digital Surround is set to 0 ms (5 ms, 10 ms, or 15 ms), that of the Dolby Pro Logic is set to 15 ms (20 ms, 25 ms or 30 ms), and vice versa.

### To adjust the speaker level balance while listening to the source

The speaker level balance can be changed after adjusting it with the noise sequencer. The balance can be changed whenever the Dolby Digital Surround or Dolby Pro Logic system is activated.

- 1 Play a disc or video software recorded in Dolby Pro Logic or Dolby Digital Surround.
- 2 Press **MANUAL SELECT** on the remote control repeatedly to select "L/R" (Left/Right balance) or "CEN" (center) or "S-R" (right surround speaker) or "S-L" (left surround speaker).
- 3 Press ◀◀ or ▶▶ on the remote control while the speaker name to be adjusted is displayed.

## ADJUSTING DOLBY DIGITAL SURROUND SOUND

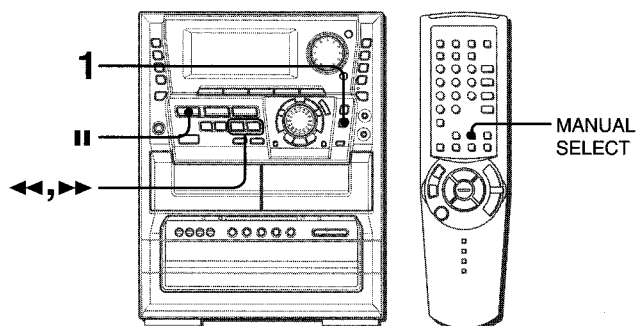

## ADJUSTING LOW FREQUENCY SOUND EFFECT(LFE)

The disc recorded in Dolby Digital Surround contains special signals called LFE to enhance low frequency sound effect. The LFE signals are recorded in some particular parts on the disc and output from the connected sub-woofer to reproduce astonishingly powerful low sound.

The sound level of the LFE signals can be adjusted according to your speakers connected while the Dolby Digital Surround is activated.

**1 Press T-BASS/LFE and hold it down until "LFE" is displayed.**

**2 Press <math>\leftarrow</math> or <math>\rightarrow</math> repeatedly to adjust the LFE level.**

The unit is initially set to 0 dB (maximum) and can be adjusted as shown below.

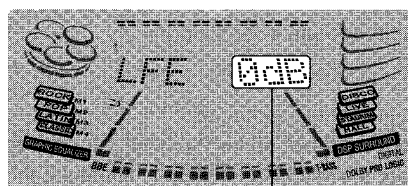

OFF  $\leftrightarrow$  -20dB  $\leftrightarrow$  -10dB  $\leftrightarrow$  0dB

### When not using a sub-woofer

While the Dolby Digital Surround (except "2ch ST") is activated, press **MANUAL SELECT** on the remote control once so that "SUBW ON" is displayed. Then, press <math>\leftarrow</math> to display "SUBW OFF." The LFE signals are redistributed to the other speakers. To restore, press **MANUAL SELECT** once so that "SUBW OFF" is displayed, then press <math>\rightarrow</math> to display "SUBW ON."

### NOTE

When setting the sub-woofer mode of the Dolby Digital Surround to "SUBW OFF," that of the Dolby Pro Logic is also set to "SUBW OFF," and vice versa. In this case, the sub-woofer signals are redistributed to the other speakers.

## ADJUSTING DYNAMIC RANGE

Dynamic range of the Dolby Digital Surround sound can be adjusted. The unit is initially set to the "STD" (standard) mode.

**1 While the Dolby Digital Surround is activated, press II SET and hold it down until "MID NIGHT THEATER" runs through on the display.**



**2 Press <math>\leftarrow</math> or <math>\rightarrow</math> to select the "MAX", "STD" or "MIN" mode.**

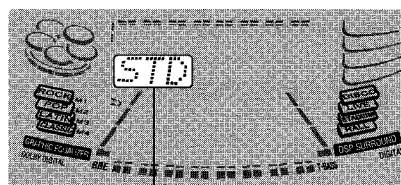

MAX  $\leftrightarrow$  STD  $\leftrightarrow$  MIN

### [MIN]

You can enjoy the full dynamic range sound like in the movie theater.

### [STD]

Original position, when playing back in home, that is recommended by the software producers.

### [MAX]

Select this mode when playing back at low volume. This is the mode when playing back in the mid night.

# MICROPHONE MIXING

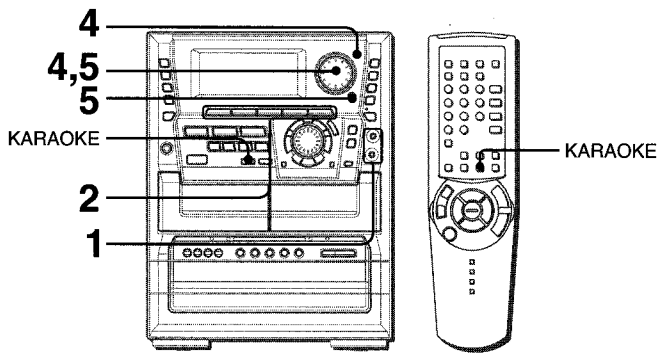

Two microphones (not supplied) can be connected to this unit, allowing you to sing along to music sources. Use microphones with mini plugs (ø3.5 mm, 1/8 inch).

## 1 Connect your microphones to MIC 1 and MIC 2 jacks.

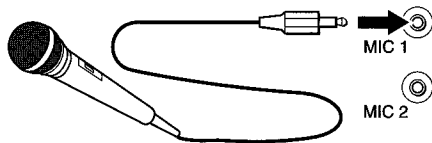

## 2 Press one of the function buttons to select the source to be mixed, and play the source.

## 3 Adjust the volume and tone of the source.

## 4 Press MIC and turn VOLUME within 4 seconds to adjust the microphone volume.

The microphone volume can be selected from 1 to MAX (7) or OFF (cancel).  
The volume of both microphones is adjusted simultaneously.

## 5 Press ECHO and turn VOLUME within 4 seconds to adjust the echo level.

The echo level can be selected from 1 to MAX (7) or OFF (cancel).

### To change the delay time of echo

Hold down **ECHO** while the echo is on. "ECHO-L" (Long) and "ECHO-M" (Medium) are displayed alternately. At the desired position, release the button.

### To record microphone sound mixed with source sound

Follow the procedure for recording from the sound source (see page 19).

**SYNC DUB** cannot be used for mixing recording.

### When not using the microphones

Set the microphone volume and echo level to OFF and remove the microphones from **MIC** jacks.

### NOTE

- MIC and ECHO are reset to OFF automatically when the function is changed, the power is turned off, or the AC cord is disconnected.
- When the ECHO level is changed, the SURROUND system is automatically canceled.
- ECHO is not applicable for Dolby Digital mode.

- If a microphone is held too near the speakers, a howling sound may be produced. In this case, hold the microphone away from the speakers, or decrease the microphone volume.
- If sound through the microphone is extremely loud, it may be distorted. In this case, decrease the microphone volume.

### Recommended microphones

The use of unidirectional type microphones is recommended to prevent howling. Contact your local Aiwa dealer for details.

## VOCAL FADER/MULTIPLEX FUNCTIONS

This unit can use discs or tapes as Karaoke sources.

Use the vocal fader function for ordinary discs or tapes.

Use the multiplex function for multi audio discs or tapes.

### Press KARAOKE repeatedly to select the vocal fader or multiplex function.

Each time **KARAOKE** is pressed, one of these functions is selected cyclically.

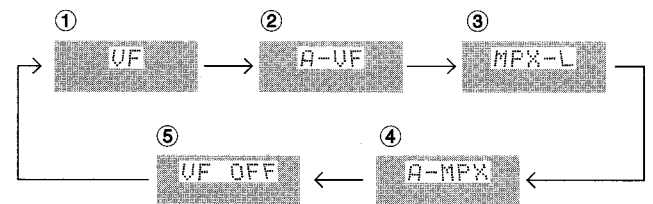

#### 1 Vocal Fader

The singer's voice becomes softer than the accompaniment.

#### 2 Auto Vocal Fader

The singer's voice becomes softer only while there is audio input through microphones.

#### 3 Multiplex

The sound on the left channel is heard from both speakers, and the sound on the right channel is muted.

#### 4 Auto Multiplex

The sound on the left channel is heard from both speakers, and the sound on the right channel is muted only while there is audio input through a microphone.

#### 5 Cancel

### To change the audible channel in Multiplex function

When Multiplex is selected, "MPX-L" is displayed for 3 seconds and changes to the selected function name. After the selected function name is displayed, keep pressing KARAOKE until "MPX-R" is displayed.

To return to the initial setting, select MPX-L.

When the power is turned off, MPX-L is restored.

### To change the time lag setting in Auto Vocal Fader or Auto Multiplex function

The muted singer's voice can be restored faster.

When Auto Vocal Fader or Auto Multiplex is selected, "A-VF" or "A-MPX" is displayed for 3 seconds and changes to the selected function name. After the selected function name is displayed, keep pressing KARAOKE until "FAST" is displayed.

To return to the initial setting, select SLOW.

When the power is turned off, SLOW is restored.

## NOTE

- The Karaoke functions may not operate correctly with the following kinds of CDs or tapes.
  - Those with monaural sound
  - Those recorded with strong echoes
  - Those with the vocal part recorded on the right or left side of the sound width
- While the Karaoke function is on, the sound is output as monaural.
- The VOCAL FADER function is automatically canceled:
  - when one of the function buttons is pressed
  - when the Dolby Pro Logic system is turned on
- The VOCAL FADER/MULTIPLEX button does not function:
  - while the Dolby Pro Logic system is activated
  - while the DIGITAL function is selected except when playing KARAOKE discs, recorded in Dolby Digital (AC-3), in the 2CH STEREO mode.

## KARAOKE DISCS RECORDED IN DOLBY DIGITAL (AC-3)

### Guide melody function

Some KARAOKE discs recorded in Dolby Digital (AC-3) are equipped with the guide melody function.

In such a disc, the main vocal part is played and recorded not by singer's voice but by an instrument so that you can sing along pleasantly and easily.

The guide melody function can be canceled.

**1 Play a KARAOKE disc recorded in Dolby Digital (AC-3) and select the 2CH STEREO mode.**

**2 Press **||** SET so that "MELODY OFF" appears on the display.**

Each time the button is pressed, the guide melody function is turned on or off.

When the playing disc does not support this function, "NO MELODY" will appear on the display.

### To use VOCAL FADER/MULTIPLEX functions

- In the DIGITAL mode, the VOCAL FADER/MULTIPLEX functions are available only when playing the KARAOKE discs recorded in Dolby Digital (AC-3).
- When enjoying KARAOKE with the discs recorded in Dolby Digital (AC-3), select the 2CH STEREO mode so that the 2CH DOWN MIX indicator lights up.

The VOCAL FADER/MULTIPLEX functions work as follows:

**Vocal Fader (VF) mode:** V1 (Vocal 1) is muted. When playing duet discs V2 (Vocal 2) is also muted.

**Auto Vocal Fader (A-VF) mode:** While there is audio input through a microphone, V1 is muted. When playing duet discs V2 is also muted.

**Multiplex (MPX-L, MPX-R) mode:** This mode is available only when playing duet discs.

**MPX-L:** V1 is output from the left channel and V2 on the right channel is muted while there is audio input through a microphone.

**MPX-R:** V2 is output from the right channel and V1 on the left channel is muted while there is audio input through a microphone.

**Normal Play (VF OFF):** V1 is output from the both channel when playing solo discs. In duet discs, V1 is output from the left channel and V2 from the right channel.

# KARAOKE PROGRAM

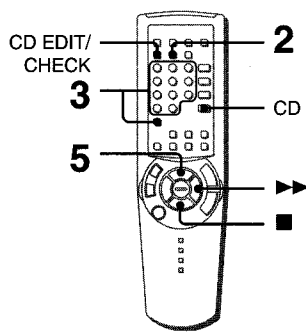

Before or during CD play, you can reserve up to 15 tracks to be played after the current track. Each reservation is cleared when it finishes playing.

Use the remote control.

**1 Press CD and load the discs.**

**2 Press PRGM once.**

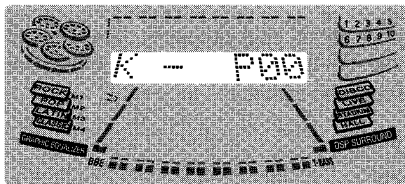

**3 Press DISC DIRECT PLAY, then press one of the numbered buttons 1-5 within 3 seconds to select a disc. Then press the numbered buttons 0-9 and +10 to program a track.**

Reserved disc number      Reserved track number

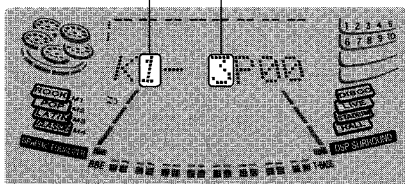

**4 Repeat step 3 to reserve other tracks.**

**5 Press ►/◄ to start play.**

After a track is played, it is cleared from the program.

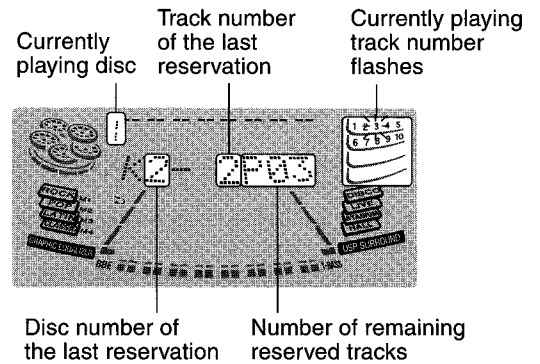

**To add a reservation during play**

Repeat step 3.

**To check the reserved tracks**

Press **CD EDIT/CHECK** repeatedly. Each time it is pressed, the disc number and track number are displayed in the reserved order.

**To stop play**

Press **■**.

When **◄►** is pressed, the play starts from the last track again.

**To skip a current track**

Press **►►**. The skipped track is cleared from the program.

**To clear all the reservations**

Press **►►** repeatedly until "K - P00" is displayed.

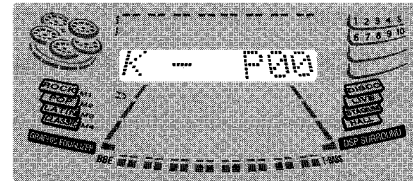

Press it once more to cancel the Karaoke program. The display returns to that of CD play.

## NOTE

- If the reserved track number does not exist on the selected disc, the unit stops playing and the display flashes. In this case, press **►►** to skip the error track. Then press **◄►** to start play with the next reserved track.
- When **PRGM** is pressed repeatedly in step 2, PRGM is displayed and the unit enters CD programmed play mode (page 15).  
To cancel programmed play, press **■ CLEAR**.

**SETTING THE CLOCK**

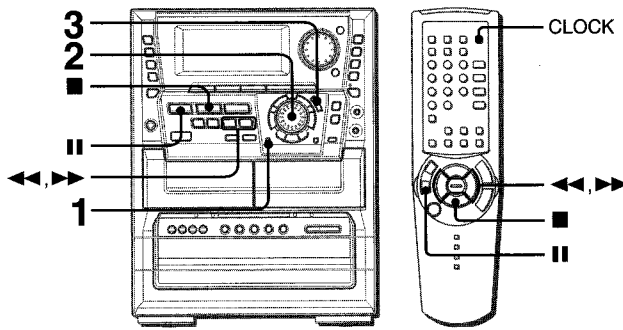

The clock is displayed. (The “:” between the hours and minutes flashes.) When the power cord is plugged into an AC outlet for the first time after purchase or when the clock setting is canceled due to a power failure, the entire clock display flashes.

**1 Press CLOCK.**



**2 Within 4 seconds, turn MULTI JOG to designate the hour and the minute.**

Turning **MULTI JOG** changes both the hour and the minute. ◀◀ or ▶▶ is also available instead of **MULTI JOG**. Holding these buttons down will vary the time rapidly.

**3 Press ENTER or ■.**

The clock starts from 00 second.

**To restore an original clock setting**

Press **CLOCK** before completing step 3 to restore the previous time setting. This cancels any new setting.

**To view the clock when another display is in the display**

Press **CLOCK**. The time is displayed for 4 seconds and then the original display reappears. However, the clock cannot be displayed during recording.

**To switch to the 24-hour standard**

Press **CLOCK** and then press ■ within 4 seconds. Repeat the same procedure to restore the 12-hour standard.

**If the clock display flashes**

This caused by a power interruption. The current time needs to be reset.

If power is interrupted for more than approximately 24 hours, all settings stored in memory after purchase need to be reset.

**NOTE**

If the power-economizing mode (page 6) is on, all the display lights turn off when the power is turned off. To view the clock, press **CLOCK** so that the time is displayed for 4 seconds.

**SETTING THE SLEEP TIMER**

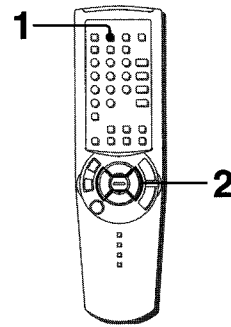

The unit can be turned off automatically at a specified time.

Use the remote control.

**1 Press SLEEP.**

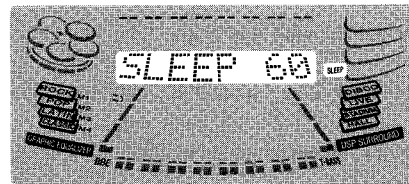

**2 Within 4 seconds, press ◀◀ or ▶▶ to specify the time until the power is turned off.**

Each time the button is pressed, the time changes between 5 and 240 minutes in 5-minute steps.

**MULTI JOG** is also available instead of ◀◀ and ▶▶.

Specified time

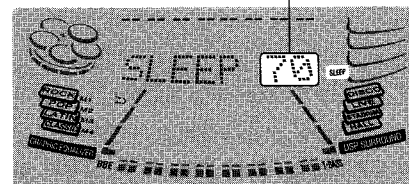

**To check the time remaining until the power is turned off**

Press **SLEEP** once. The remaining time is displayed for 4 seconds.

**To cancel the sleep timer**

Press **SLEEP** twice so that “SLEEP OFF” appears on the display.



# SETTING THE TIMER

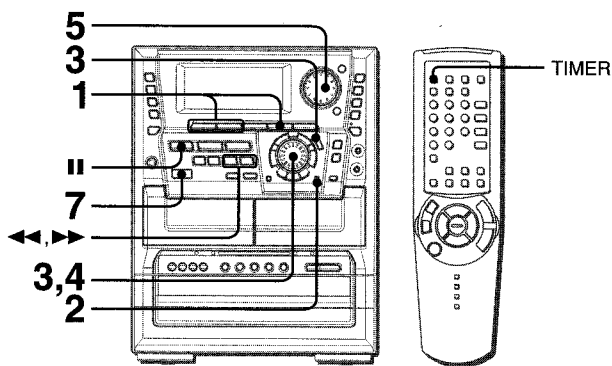

The unit can be turned on at a specified time every day with the built-in timer.

## Preparation

Make sure the clock is set correctly.

### 1 Press one of the function buttons to select a source.

- If **TUNER/BAND** is pressed, the band cannot be selected in this step.

### 2 Press **TIMER** repeatedly until ⊖ appears on the display.

Time and audio source name flash alternatively.

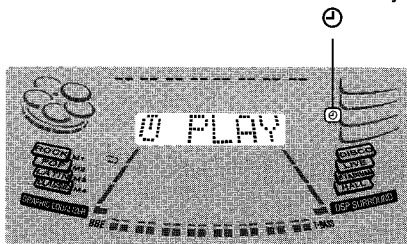

### 3 Within 6 seconds, turn **MULTI JOG** to designate the timer-on time, then press **ENTER** or **||**.

Turning **MULTI JOG** changes both the hour and the minute.

◀◀ or ▶▶ is also available instead of **MULTI JOG**. Holding these buttons down will vary the time rapidly.

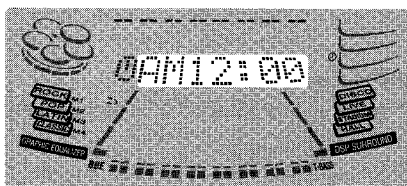

### 4 Within 4 seconds, turn **MULTI JOG** to select the duration for the timer-activated period.

The duration can be set between 5 and 240 minutes in 5-minute steps.

◀◀ or ▶▶ is also available instead of **MULTI JOG**.

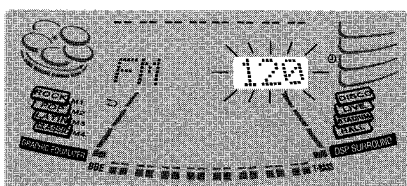

The duration will be automatically set after 4 seconds. It will also be set if **ENTER** or **||** is pressed within 4 seconds after step 4.

### 5 Adjust the volume.

The source sound will play at the volume level set in this step when the power is turned on by the timer.

If the volume level is set to 21 or higher, however, it will automatically be set to 20 when the power is turned on.

### 6 Prepare the source.

**To listen to a CD**, load the disc to be played first on tray 1.

**To listen to a tape**, insert the tape into deck 1 or 2.

**To listen to the radio**, tune in to a station.

### 7 Press **POWER** to turn off the power.

When the timer-on time is reached, the unit turns on and begins play with the selected source.

## NOTE

You can change the source that was selected in step 1 by pressing one of the function buttons before pressing **ENTER** or **||** in step 3.

### To check the timer setting

Press **TIMER**.

The selected source, the timer-on time, and the duration for the timer-activated period will be displayed for 6 seconds.

### To change any of the previous setting

Carry out from step 1.

However, if you do not change the timer-on time, in step 3 just press **ENTER** twice and continue from step 4.

### To cancel timer standby mode temporarily

Press **TIMER** repeatedly so that ⊖ disappears.

To restore the timer standby mode, press again to display ⊖.

### Using the unit while the timer is set

You can use the unit normally after setting the timer.

Before turning off the power, carry out step 5 and 6.

## NOTE

- Timer playback and timer recording will not begin unless the power is turned off.
- Connected equipment cannot be turned on and off by the built-in timer of this unit. Use an external timer.

## TIMER RECORDING

Timer recording is applicable for **TUNER**, **VIDEO/AUX** or **MD** (with an external timer) sources only.

Press either **TUNER/BAND**, **VIDEO 1/DVD/AUX** or **VIDEO 2/LD/MD** to select a source, then **press TIMER repeatedly until ⊖ REC appears on the display.**

**Within 6 seconds**, carry out the steps of "SETTING THE TIMER" from step 3 and insert the tape to be recorded into deck 2 after step 6.

## NOTE

- When the power-economizing mode (page 6) has been turned on, the timer recording volume level will be 0 (minimum level).
- You cannot use the timer function to record from a CD or tape.



## CONNECTING OPTIONAL EQUIPMENT

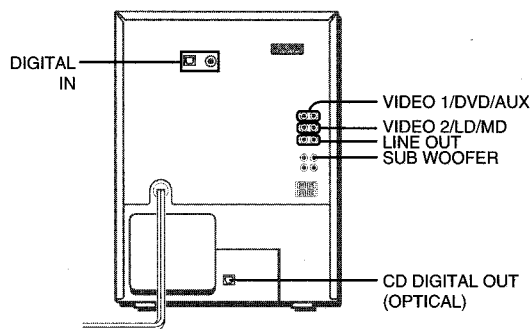

Refer to the operating instructions of the connected equipment for details.

- The connecting cords are not supplied. Obtain the necessary connecting cords.
- Consult your local Aiwa dealer for optional equipment.

## VIDEO1/DVD/AUX OR VIDEO2/LD/MD JACKS

This unit can input analog sound signals through these jacks. Use a cable with RCA phono plugs to connect audio equipment (turntables, LD players, MD players, VCRs, TV, etc.). Connect the red plug to the **R** jack, and the white plug to the **L** jack.

- When audio equipment is connected to **VIDEO 2/LD/MD** jack, no sound will be output from the **LINE OUT** jacks.

## When connecting a turntable

Use an Aiwa turntable equipped with a built-in equalizer amplifier.

## LINE OUT JACKS

This unit can output analog sound signal through these jacks. Use a cable with RCA phono plugs to connect audio equipment with **LINE IN** (analog input) jacks. Connect the red plug to **LINE OUT R** jack and the white plug to **LINE OUT L** jack.

## NOTE

Do not connect an equipment to **LINE OUT** and **VIDEO1/DVD/AUX** or **VIDEO2/LD/MD** jacks simultaneously. Otherwise, noise is generated and malfunction occurs.

## SUB WOOFER JACK

Connect an optional powered sub woofer with a built-in amplifier to the jack.

## CD DIGITAL OUT (OPTICAL) JACK

This unit can output CD digital sound signals through this jack. Use an optical cable to connect digital audio equipment (DAT deck, MD recorder, etc.).

Remove the dust cap **a** from the **CD DIGITAL OUT (OPTICAL)** jack. Then, connect an optical cable plug to the **CD DIGITAL OUT (OPTICAL)** jack.

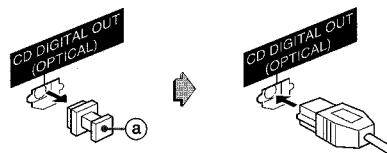

When the **CD DIGITAL OUT (OPTICAL)** jack is not being used

Attach the supplied dust cap.

## DIGITAL IN JACKS

This unit can input digital AC-3/PCM sound signals through these jacks.

Use an optical cable to connect digital audio equipment (DVD player, LD player, etc.) with the **OPTICAL DIGITAL IN** jack. Remove the dust cap from the **OPTICAL DIGITAL IN** jack. Then, connect an optical cable plug to the **OPTICAL DIGITAL IN** jack. Use a coaxial cable to connect digital audio equipment with the **COAXIAL DIGITAL IN** jack.

When the **OPTICAL DIGITAL IN** jack is not being used

Attach the supplied dust cap.

## NOTE

- If the DVD, CD, MD or LD player is not connected to **VIDEO 1/ DVD/ AUX** or **VIDEO 2/ LD/ MD** jack of this unit:
  - the spectrum analyzer does not show the sound level of the connected equipment.
  - the input sound of the connected equipment through **DIGITAL IN** jacks cannot be recorded.
- To remove these limitations, connect the analog **LINE OUT** jacks of the equipment to the corresponding **VIDEO 1/ DVD/ AUX** or **VIDEO 2/ LD/ MD** jack of this unit besides connecting to **DIGITAL IN** jacks. The signals through **VIDEO 1/ DVD/ AUX** or **VIDEO 2/ LD/ MD** jacks enable the spectrum analyzer to work and the recording to be done. The sound will be recorded in 2ch stereo.
- Refer also to the operating instructions of the connected equipment.
- **DOLBY DIGITAL SURROUND** sound cannot be recorded in any way.

## LISTENING TO EXTERNAL SOURCES

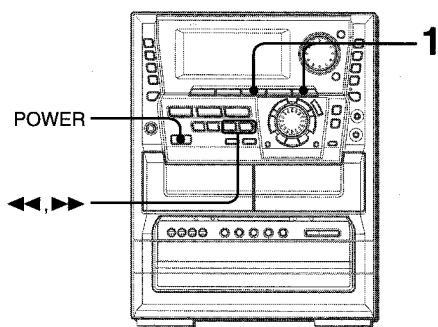

To play equipment connected to **VIDEO 1/ DVD/ AUX** or **VIDEO 2/ LD/ MD** jacks, proceed as follows.

### 1 Press VIDEO 1/ DVD/ AUX or VIDEO 2/ LD/ MD.

To play the equipment connected to **VIDEO 1/ DVD/ AUX**, press **VIDEO 1/ DVD/ AUX**. "VIDEO1" appears on the display.

To play the equipment connected to **VIDEO 2/ LD/ MD**, press **VIDEO 2/ LD/ MD**. "VIDEO2" appears on the display.

### 2 Play the connected equipment.

#### To change a source name in the display

When **VIDEO 1/ DVD/ AUX** is pressed, "VIDEO1" is displayed initially. It can be changed to "DVD" or "AUX".

With the power on, press **POWER** while pressing **VIDEO 1/ DVD/ AUX**. Repeat the procedure to select one of the names.

"VIDEO2" displayed can also be changed to "LD" or "MD".

With the power on, press **POWER** while pressing **VIDEO 2/ LD/ MD**. Repeat the procedure to select one of the names.

#### To adjust the sound level of the external source

This unit is equipped with the **OVERLOAD** indicator. When input analog signals from the connected equipment are too high to accept, "OVERLOAD" will be displayed.

When "OVERLOAD" is displayed or when the sound level of the external sources is much lower than that of other function sources, adjust it as follows.

1 Press **VIDEO 1/ DVD/ AUX** or **VIDEO 2/ LD/ MD** and play the equipment.

2 Press **◀** or **▶** so that the sound level becomes the same as that of other function sources.

#### NOTE

During recording, the sound level cannot be adjusted.

## TO PLAY A DVD OR LD RECORDED IN DOLBY DIGITAL SURROUND

This receiver is equipped with the Dolby Digital decoder and has the **DIGITAL IN** (both **OPTICAL** and **COAXIAL**) terminals. When a DVD or LD player is connected to the **DIGITAL IN** terminal of the receiver, you can enjoy theater-quality audio right in your home when playing discs recorded in Dolby Digital Surround.

1 Keep **VIDEO 1/ DVD/ AUX** (or **VIDEO 2/ LD/ MD**) pressed for about 3 seconds until "DIGITAL" and "ANALOG" toggles on the display. Release the button when "DIGITAL" is shown.

The DVD (LD) player connected to **OPTICAL (COAXIAL) DIGITAL IN** jack is selected as a source.

2 Start playing the DVD (LD) recorded in Dolby Digital Surround.

The "DOLBY DIGITAL" indicator will light on the display when the bit stream of the Dolby Digital Surround comes in the unit. To select the Dolby Digital Surround mode according to your speakers, see "SELECTING DOLBY SURROUND" on page 23.

#### NOTE

- When headphones are plugged in, the Dolby Digital Surround mode is automatically changed to "2ch ST". Even if the **DOLBY SURROUND** button is pressed while the headphones are plugged in, the mode cannot be changed.
- This unit supports input signals of the Dolby Digital Surround bit stream and linear PCM whose sampling frequency is 32 kHz, 44.1 kHz and 48 kHz. The unit cannot play the DVDs whose sampling frequency is 96 kHz.
- When connecting some DVD player to the receiver through the **DIGITAL IN** terminals, noise may be heard in the DVD operation: e.g. searching a disc, skipping a chapter.
- Make sure the software played back with the connected equipment support the **DOLBY DIGITAL SURROUND**.
- "Can't USE" is displayed if you attempt to activate the Rhythm Play function, **ECHO** or **DSP SURROUND** when the Dolby Digital Surround is activated.

#### To adjust the sound levels of the speakers in DOLBY DIGITAL SURROUND

Select **DOLBY D** mode.

Use the remote control from step 2 to 4.

- 1 Keep **VIDEO 1/ DVD/ AUX** (or **VIDEO 2/ LD/ MD**) pressed until "DIGITAL" appears on the display.
- 2 Press **MANUAL SELECT** repeatedly. Speaker names appear in turn as follows:

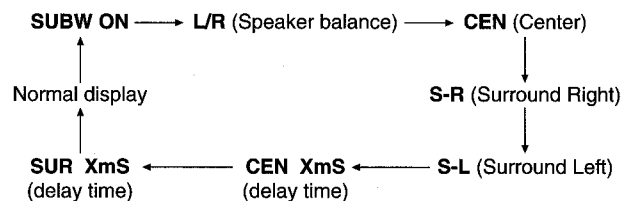

3 Press **◀** or **▶** to adjust the sound level while "CEN", "S-L", or "S-R" is displayed.

Each level can be adjusted between -10dB and +10dB.

4 Repeat steps 2 and 3 to adjust each speaker's sound level.

#### NOTE

If the surround speakers or the center speaker level of the **DOLBY DIGITAL SURROUND** is changed, that of the **DOLBY PRO LOGIC** (page 23) is also changed.

## CARE AND MAINTENANCE

Occasional care and maintenance of the unit and the software are needed to optimize the performance of your unit.

### To clean the cabinet

Use a soft and dry cloth.

If the surfaces are extremely dirty, use a soft cloth lightly moistened with mild detergent solution. Do not use strong solvents, such as alcohol, benzine or thinner as these could damage the finish of the unit.

### To clean the tape heads

When the tape heads are dirty;

- high frequency sounds is not emitted
- the sound is not adequately high
- the sound is off-balance
- the tape cannot be erased
- the tape cannot be recorded on

After every 10 hours of use, clean tape heads with a head cleaning cassette.

Use separately sold dry-type or wet-type cleaning cassette.

Refer to the instructions of the cleaning cassette for details.

### To demagnetize the tape heads

The tape heads may become magnetized after long-term use. This may narrow the output range of recorded tapes and increase noise.

After every 20 to 30 hours of use, demagnetize the tape heads with a separately sold demagnetizing cassette.

Refer to the instructions of the demagnetizing cassette for details.

### Care of discs

- When a disc becomes dirty, wipe the disc from the center out with a cleaning cloth.

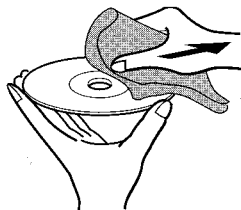

- After playing a disc, store the disc in its case. Do not leave the disc in places that are hot or humid.

### Care of tapes

- Store tapes in their cases after use.
- Do not leave tapes near magnets, motors, television sets, or any source of magnetism. This will downgrade the sound quality and cause noise.
- Do not expose tapes to direct sunlight, or leave them in a car parked in direct sunlight.

### To reset

If an unusual condition occurs in the display window, the cassette decks or CD player, reset the unit as follows.

- 1 Press **POWER** to turn off the power.
- 2 Press **POWER** to turn the power back on while pressing **■ CLEAR**. Everything stored in memory after purchase is canceled.

If the power cannot be turned off in step 1 because of a malfunction, reset by disconnecting the AC cord and connect it again. Then carry out step 2.

## TROUBLESHOOTING GUIDE

If the unit fails to perform as described in these Operating Instructions, check the following guide.

### GENERAL

#### There is no sound.

- Is the AC cord connected properly?
- Is there a bad connection? (→ page 3 and 4)
- There may be a short circuit in the speaker terminals.
  - Disconnect the AC cord, then correct the speaker connections.
- Was an incorrect function button pressed?

#### Sound is emitted from one speaker only.

- Is the other speaker disconnected?

#### The output sound is not stereo.

- Is the Karaoke function turned on? (→ page 27)

#### An erroneous display or a malfunction occurs.

- Reset the unit as stated below.

#### The power is not turn on.

- Disconnect the AC cord, and connect it again in a few seconds.

### TUNER SECTION

#### There is constant, wave-like static.

- Is the antenna connected properly? (→ page 4)
- Is the signal weak?
  - Connect an outdoor antenna.

#### The reception contains noise interferences or the sound is distorted.

- Is the system picking up external noise or multipath distortion?
  - Change the orientation of the antenna.
  - Move the unit away from other electrical appliances.

### CASSETTE DECK SECTION

#### The tape does not run.

- Is deck 2 in pause mode? (→ page 17)

#### The sound is off-balance or not adequately high.

- Is the playback head dirty? (→ page 34)

#### Recording is not possible.

- Is the erasure prevention tab on the tape broken off? (→ page 18)
- Is the recording head dirty? (→ page 34)

#### Erasure is not possible.

- Is the erasure head dirty? (→ page 34)
- Is a metal tape being used?

#### High frequency sound is not emitted.

- Is a tape recorded without Dolby NR played back with the Dolby NR system operating? (→ page 17)
- Is the recording/playback head dirty? (→ page 34)

### CD PLAYER SECTION

#### The CD player does not play.

- Is the disc correctly inserted? (→ page 13)
- Is the disc dirty? (→ page 34)
- Is the lens affected by condensation?
  - Wait approximately one hour and try again.

# SPECIFICATIONS

## Main unit CX-NDS15

### FM tuner section

Tuning range	87.5 MHz to 108 MHz
Usable sensitivity (IHF)	13.2 dBf
Antenna terminals	75 ohms (unbalanced)

### AM tuner section

Tuning range	530 kHz to 1710 kHz (10 kHz step) 531 kHz to 1602 kHz (9 kHz step)
Usable sensitivity	350 $\mu$ V/m
Antenna	Loop antenna

### Amplifier section

Power output	<b>Front</b> 155 W + 155 W (50 Hz – 20 kHz, THD less than 1%, 6 ohms) <b>Rear (Surround)</b> 33 W + 33 W (1 kHz, THD less than 1%, 8 ohms) <b>Center</b> 34 W (1 kHz, THD less than 1%, 8 ohms)
--------------	---

**Total harmonic distortion** 0.1% (100 W, 1 kHz, 6 ohms, DIN AUDIO/front)

Inputs	VIDEO 1/ DVD/ AUX: 280 mV (adjustable) VIDEO 2/ LD/ MD: 280 mV (adjustable) MIC 1, MIC 2: 1.4 mV (10 kohms) DIGITAL IN COAXIAL (VIDEO 2): OPTICAL (VIDEO 1): accept linear PCM (32 kHz, 44.1 kHz and 48 kHz) signals and bit stream of Dolby Digital Surround
--------	---

Outputs	LINE OUT: 200 mV SUB WOOFER: 1 V SPEAKERS: accept speakers of 6 ohms or more SURROUND SPEAKERS: accept speakers of 8 ohms to 16 ohms CENTER SPEAKER: accept speakers of 8 ohms or more PHONES (stereo jack): accepts headphones of 32 ohms or more
---------	---

### Cassette deck section

Track format	4 tracks, 2 channels stereo
Frequency response	CrO <sub>2</sub> tape: 50 Hz – 16000 Hz Normal tape: 50 Hz – 15000 Hz
Signal-to-noise ratio	60 dB (Dolby B NR ON, CrO <sub>2</sub> tape peak level)
Recording system	AC bias
Heads	Deck 1: Playback head $\times$ 1 Deck 2: Recording/playback $\times$ 1, erase head $\times$ 1

### Compact disc player section

Laser	Semiconductor laser ( $\lambda = 780$ nm)
D-A converter	1 bit dual
Signal-to-noise ratio	83 dB (1 kHz, 0 dB)
Harmonic distortion	0.05 % (1 kHz, 0 dB)
Wow and flutter	Unmeasurable

## General

Power requirements	120 V AC, 60 Hz
Power consumption	220 W
Dimensions of main unit (W $\times$ H $\times$ D)	300 $\times$ 383.5 $\times$ 380 mm (11 <sup>7</sup> / <sub>8</sub> $\times$ 15 <sup>1</sup> / <sub>8</sub> $\times$ 15 in.)
Weight of main unit	13 kg (28 lbs 11 oz)

## Standby power consumption

If the power-economizing mode is OFF: 36W  
If the power-economizing mode is ON: 1.5W

## Speaker system SX-ND8

Cabinet type	3 way, bass reflex (magnetic shielded type)
Speakers	Woofer: 160 mm (6 <sup>3</sup> / <sub>8</sub> in.) cone type Tweeter: 60 mm (2 <sup>3</sup> / <sub>8</sub> in.) cone type Super tweeter: 20 mm (1 <sup>3</sup> / <sub>16</sub> in.) ceramic type
Impedance	6 ohms
Output sound pressure level	87 dB/W/m
Dimensions (W $\times$ H $\times$ D)	250 $\times$ 383 $\times$ 285 mm (9 <sup>7</sup> / <sub>8</sub> $\times$ 15 <sup>1</sup> / <sub>8</sub> $\times$ 11 <sup>1</sup> / <sub>4</sub> in.)
Weight	5.8 kg (12 lbs 14 oz)

Specifications and external appearance are subject to change without notice.

## BBE SYSTEM

The word "BBE" and the "BBE symbol" are trademarks of BBE Sound, Inc.  
Under license from BBE Sound, Inc.

Manufactured under license from Dolby Laboratories.

"Dolby", "Pro Logic" and the double-D symbol are trademarks of Dolby Laboratories. Confidential unpublished Works. ©1992-1997 Dolby laboratories, Inc. All rights reserved.

## NOTE

This equipment has been tested and found to comply with the limits for a Class B digital device, pursuant to Part 15 of the FCC Rules. These limits are designed to provide reasonable protection against harmful interference in a residential installation. This equipment generates, uses, and can radiate radio frequency energy and, if not installed and used in accordance with the instructions, may cause harmful interference to radio communications. However, there is no guarantee that interference will not occur in a particular installation. If this equipment does cause harmful interference to radio or television reception, which can be determined by turning the equipment off and on, the user is encouraged to try to correct the interference by one or more of the following measures:

- Reorient or relocate the receiving antenna.
- Increase the separation between the equipment and receiver.
- Connect the equipment into an outlet on circuit different from that to which the receiver is connected.
- Consult the dealer or an experienced radio/TV technician for help.

## CAUTION

Modifications or adjustments to this product, which are not expressly approved by the manufacturer, may void the user's right or authority to operate this product.

# PARTS INDEX

# INDICE DE LAS PARTES

# NOMENCLATURE

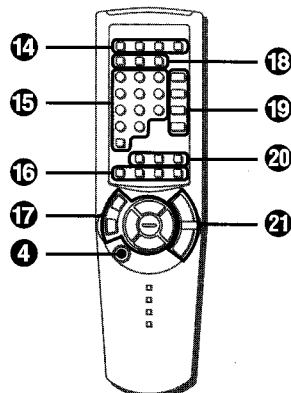
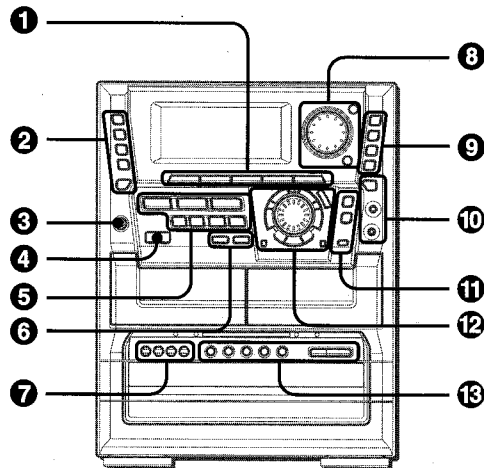

**Name/Nombre/Nom**                      **Page/Página/Page**

① TAPE/DECK 1/2 .....	6, 17-20
TUNER/BAND .....	16
VIDEO1/DVD/AUX .....	33
CD .....	6, 13
VIDEO2/LD/MD .....	33
② ROCK/M1 .....	11, 12
POP/M2 .....	11, 12
LATIN/M3 .....	11, 12
CLASSIC/M4 .....	11, 12
PRGM/MANU .....	11, 12
③ PHONES .....	8
④ POWER .....	6, 16, 34
⑤ ■■SET .....	13, 16, 26, 28, 30, 31
■ CLEAR .....	6, 13, 15-22, 29, 30, 34
◀▶ DIRECTION/PRESET .....	6, 13-18
◀◀/▶▶ DOWN .....	6, 7, 12, 15-18, 21, 22, 26, 30, 31
▶▶/▶▶ UP .....	6, 7, 12, 13, 15-18, 21, 22, 26, 29-31
● REC/REC MUTE .....	19-22
SYNC DUB .....	20
⑥ KARAOKE .....	27
DOLBY SURROUND .....	23, 24
⑦ DOLBY NR .....	17, 19-22
REV MODE (DECK 2) .....	17-19
CD EDIT/CHECK .....	13, 21, 22, 29
CD BLANK SKIP .....	14
⑧ VOLUME .....	7, 27
MIC .....	27
ECHO .....	27
⑨ DISCO .....	12
LIVE .....	12
STADIUM .....	12
HALL .....	12
⑩ ECO .....	6, 7
MIC 1, 2 .....	27
⑪ BBE .....	7
T-BASS/LFE .....	8, 26
DEMO .....	6

**Name/Nombre/Nom**                      **Page/Página/Page**

⑫ FREQUENCY UP, DOWN .....	12
MULTI JOG .....	6, 7, 8-13, 16, 30, 31
BEAT ON/OFF .....	9
RHYTHM .....	9, 11
ENTER .....	6, 12, 30, 31
SPICE A, B .....	10, 11
AUTO SPICE/FILL IN .....	10, 11
CLOCK .....	30
TIMER .....	31
⑬ DISC DIRECT PLAY 1-5 .....	13, 21, 22, 29
DISC CHANGE .....	13
▲ OPEN/CLOSE .....	13
⑭ TIMER .....	31
SLEEP .....	30
MONO TUNER .....	16
CLOCK .....	30
⑮ 0-9, +10 .....	13, 16, 21, 22, 29
DISC DIRECT PLAY .....	13, 21, 22, 29
⑯ T-BASS .....	8
GEQ .....	11
KARAOKE .....	27
▲ OPEN/CLOSE .....	13
⑰ ●/○REC/REC MUTE .....	19-22
■■SET .....	13, 16, 26, 30, 31
▶/◀ PRESET .....	5, 6, 13-18
◀◀/▶▶ TUNING DOWN UP ▶▶/▶▶ .....	6, 8, 12, 13, 15-18, 21, 22, 25, 26, 29-31, 33
■ CLEAR .....	6, 13, 15-22, 29, 30, 34
⑱ CD EDIT/CHECK .....	13, 21, 22, 29
PRGM .....	15, 29
RANDOM/REPEAT .....	14
⑲ TAPE/DECK 1/2 .....	6, 17-20
TUNER/BAND .....	16
VIDEO/AUX .....	33
CD .....	6, 13
⑳ SURROUND .....	12
MANUAL SELECT .....	7, 12, 24-26, 33
DOLBY SURROUND .....	23, 24
㉑ VOL (∧, ∨) .....	7

For assistance and information,

**call toll free 1-800-BUY-AIWA.** (United States and Puerto Rico)